

# Adjustable-blade swirl diffusers

<b>Contents</b>	<b>Page</b>
<b>Adjustable-blade swirl diffusers</b>	
Models _____	4
Description _____	4
Preselection based on sound level and pressure drop _____	5
Symbols. Legend _____	6
Selection from graphs. Example _____	7
<b>DR-RO swirl diffusers</b>	
Basic sizes _____	8
Square panels for modular false ceiling, <b>DF-RO</b> . Dimensions _____	8
Square panels for plaster false ceiling, <b>DF-RO-E</b> . Dimensions _____	8
Connection plenum, <b>PQ</b> , for square panels. Dimensions _____	8
Round panels for false ceiling, <b>DF-RO-C</b> . Dimensions _____	9
Connection plenum, <b>PC</b> , for round panels. Dimensions _____	9
Coding for purchase orders. Example _____	9
Selection tables _____	10
Selection graphs _____	12
<b>DF-RA swirl diffusers</b>	
Basic sizes _____	16
Square panels for modular false ceiling, <b>DF-RA</b> . Dimensions _____	16
Square panels for plaster false ceiling, <b>DF-RA-E</b> . Dimensions _____	16
Connection plenum, <b>PQ</b> , for square panels. Dimensions _____	16
Round panels for false ceiling, <b>DF-RA-C</b> . Dimensions _____	17
Connection plenum, <b>PC</b> , for round panels. Dimensions _____	17
Coding for purchase orders. Example _____	17
Selection tables _____	18
Selection graphs _____	20
<b>DF-RQ swirl diffusers</b>	
Basic sizes _____	24
Square panels for modular false ceiling, <b>DF-RQ</b> . Dimensions _____	24
Square panels for plaster false ceiling, <b>DF-RQ-E</b> . Dimensions _____	24
Connection plenum, <b>PQ</b> , for square panels. Dimensions _____	24
Coding for purchase orders. Example _____	25
Selection tables _____	26
Selection graphs _____	28
<b>Adjustable-blade swirl diffusers</b>	
Research, design and innovation _____	30

## Adjustable-blade swirl diffusers



**DF-RQ diffuser**

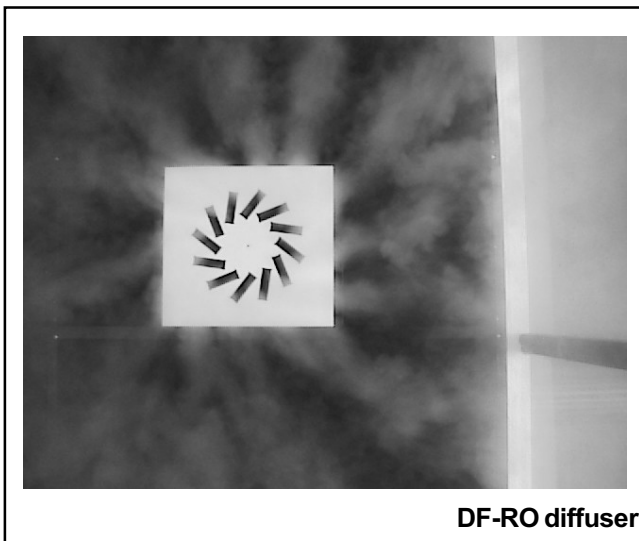

**DF-RO diffuser**

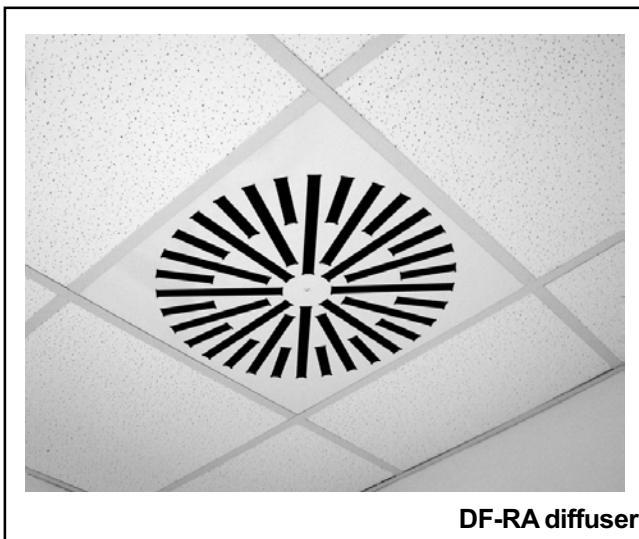

**DF-RA diffuser**

### Models

Increasingly stringent requirements from the standpoint of technical features (higher supply flow rates and lower velocities in the occupant area) and aesthetics (smoother incorporation in the interior design) have generally made swirl diffusers a better choice for air diffusion.

Mech-Elec has enlarged its range of adjustable-blade swirl diffusers and now provides eight sizes of its well-known **DF-RO** diffuser, a unit with non-radial slot pattern for an "open" or "concentrated" swirl distribution.

The new **DF-RA** model retains the excellent features of the **DF-RO** model, but modifies the aesthetics of the diffuser by using a radial pattern for the deflectors.

The **DF-RQ** model is an alternative model with a whole new look that differs models currently available on the market and allows a reduction in the distance between diffusers or between the diffuser and the wall, thus achieving residual velocities below those of "conventional" swirl diffusers.

The recommended mounting height is around 2.5 to 4.0 m for all models. All these units can be used in VAV systems, allowing the flow rate to be reduced up to 25% of the nominal air flow rate without producing uncomfortable air currents in the facility.

### Description

The adjustable-blade swirl diffusers supplied by Mech-Elec are made entirely of steel sheet. The diffusers basically consist of the following:

- Front diffuser integrated in a panel that can be adapted to modular ceiling formats currently available on the market, with special models for square or round installation in plaster ceilings, etc.  
The standard diffuser finish is white (RAL9010) with adjustable blades in black (RAL 9005). Other finishes can be supplied by special order upon prior consultation with our Sales Department.
- Connection plenum in galvanized steel sheet with internal equalizer panel to ensure proper air distribution and air inlet of standard ISO diameter with manual damper. The standard model of this damper is accessible from the false ceiling, although a special installation type also allows the user to make adjustments from the room using a hidden screw. An electrical servo drive for applications in VAV systems can also be added.

The front diffuser is attached to the plenum by a single screw in the middle, except for 48-slot diffusers, which require an additional four screws due to the panel dimensions (794 x 794).

## Adjustable-blade swirl diffusers

### Preselection based on sound level and pressure drop

The tables shown below allow quick identification of the flow rate that can be supplied by each basic diffuser size for each of the available models:

- DF-RO (8 basic sizes)
- DF-RA (8 basic sizes)
- DF-RQ (4 basic sizes)

Since all swirl diffusers supplied by Mech-Elec can be integrated in different panel sizes, the table indicates the minimum dimensions of the panel in which each basic size can be fitted.

Each table contains four columns corresponding to four sound pressure levels: 30, 35, 40 and 45 dB (A), indicating in each cell the flow rate, expressed in m<sup>3</sup>/h, and the total pressure drop generated (in parentheses), expressed in Pa, in the basic size of the selected row.

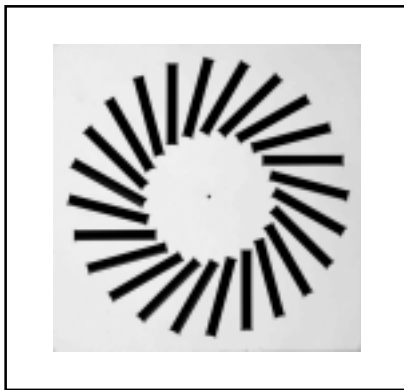

DF-RO: FLOW RATE - SOUND POWER- $\Delta P_t$					
Size	Minimum panel dimensions	m <sup>3</sup> /h (Pa)			
		30 dB(A)	35 dB(A)	40 dB(A)	45 dB(A)
12	294 x 294	175 (22)	210 (31)	245 (43)	290 (61)
16	394 x 394	255 (13)	305 (18)	360 (26)	425 (35)
20	494 x 494	365 (16)	430 (22)	510 (30)	600 (42)
24	594 x 594	495 (14)	580 (19)	685 (27)	810 (37)
32	594 x 594	570 (15)	675 (21)	795 (29)	940 (41)
36	623 x 623	600 (16)	705 (22)	835 (31)	985 (43)
40	670 x 670	735 (16)	870 (22)	1025 (30)	1210 (42)
48	794 x 794	890 (15)	1050 (21)	1240 (29)	1465 (41)

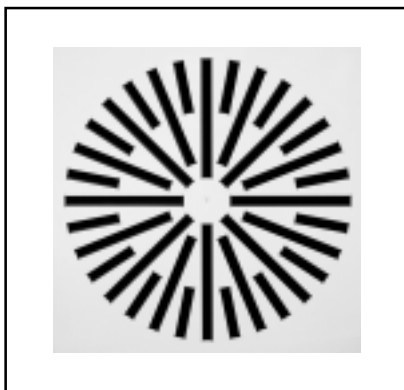

DF-RA: FLOW RATE - SOUND POWER- $\Delta P_t$					
Size	Minimum panel dimensions	m <sup>3</sup> /h (Pa)			
		30 dB(A)	35 dB(A)	40 dB(A)	45 dB(A)
12	294 x 294	175 (23)	210 (32)	250 (46)	300 (66)
16	394 x 394	265 (13)	315 (19)	375 (26)	450 (38)
20	494 x 494	370 (15)	445 (22)	530 (30)	635 (41)
24	594 x 594	510 (14)	610 (20)	730 (27)	870 (40)
32	594 x 594	570 (15)	685 (21)	815 (30)	975 (43)
36	623 x 623	615 (16)	735 (22)	880 (32)	1050 (46)
40	670 x 670	755 (15)	905 (22)	1080 (30)	1290 (42)
48	794 x 794	905 (15)	1080 (21)	1290 (30)	1540 (42)

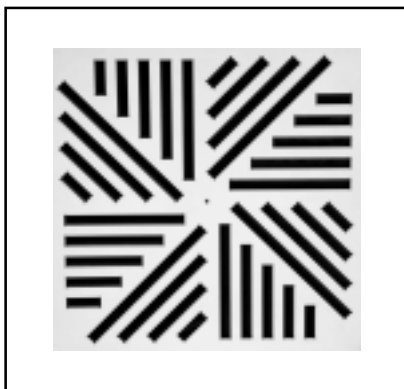

DF-RQ: FLOW RATE - SOUND POWER- $\Delta P_t$					
Size	Minimum panel dimensions	m <sup>3</sup> /h (Pa)			
		30 dB(A)	35 dB(A)	40 dB(A)	45 dB(A)
28	494 x 494	420 (18)	490 (25)	580 (34)	680 (48)
36	594 x 594	655 (18)	770 (24)	900 (34)	1060 (46)
40	670 x 670	820 (15)	965 (21)	1130 (29)	1325 (40)
48	794 x 794	960 (16)	1130 (22)	1330 (30)	1560 (42)

## Adjustable-blade swirl diffusers

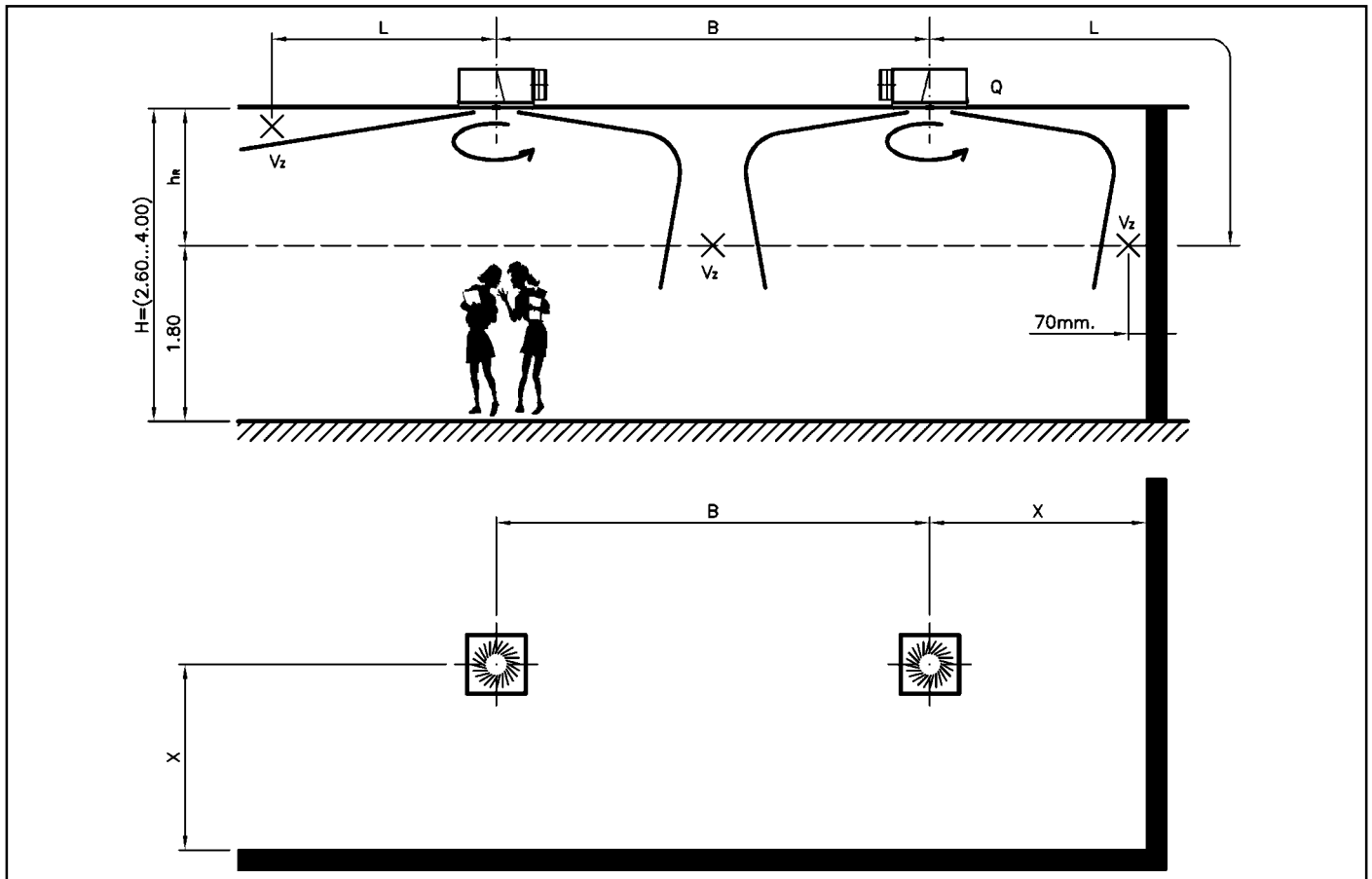

### Legend

- B = Distance between diffuser axes, in m.
- X = Distance between diffuser axis and wall, in m.
- $h_R$  = Distance between ceiling and occupied area, in m.
- L =  $X + h_R$ , in m.
- H = Room height, in m.
- Q = Air flow per diffuser, in  $\text{m}^3/\text{h}$  and in l/s.
- $V_z$  = Air flow velocity in occupied area, in m/s.
- $\Delta P_t$  = Pressure drop, in Pa.
- $L_{WA}$  = Sound power, in dB(A).

# Adjustable-blade swirl diffusers

## Selection from graphs. Example

The selection graphs contained in this catalogue are similar for the various models: **DF-RO**, **DF-RA** and **DF-RQ**, allowing the following parameters to be obtained from the supply flow rate and diffuser layout on the ceiling:

- Pressure drop and sound power level generated in plenum-diffuser assembly.
- Air flow velocity in occupied area at the two most adverse points a priori:
  - At the midpoint between two diffusers
  - At the wall closest to the diffuser

The methodology is explained below with an example.

### Initial data

Diffuser model: **DF-RO-24xx**  
 Unit flow rate of supply air: **600 m<sup>3</sup>/h**  
 Distance between diffuser axes: **B = 3 m**  
 Distance between diffuser axis and nearest wall: **X = 1,8 m**  
 Room height: **H = 3 m**

### Results

Pressure loss: **20 Pa**  
 Sound power level: **36 dB(A)**  
 Based on the symbols from the previous page, we have:  
 $h_R = H - 1,80 = 1,2$  m  
 Between diffusers, we have:  $V_z = 0,18$  m/s  
 For the wall area graph, we calculate:  
 $L = X + h_R = 1,8 + 1,2 = 3,0$  m  
 In the wall area, we have:  $V_z = 0,24$  m/s

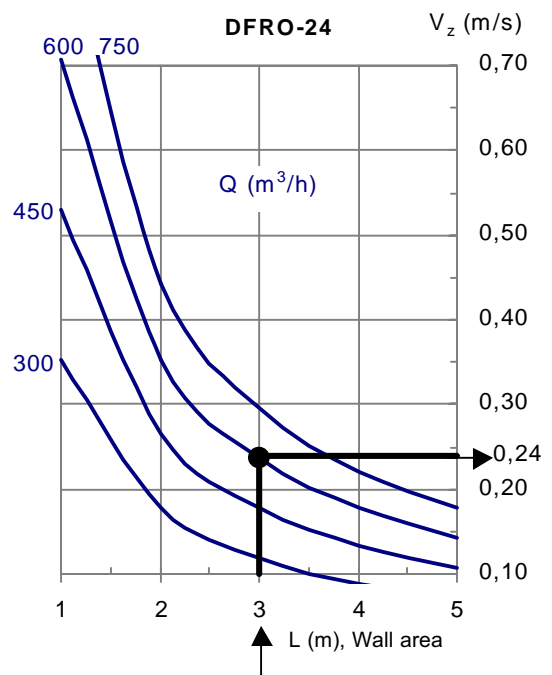
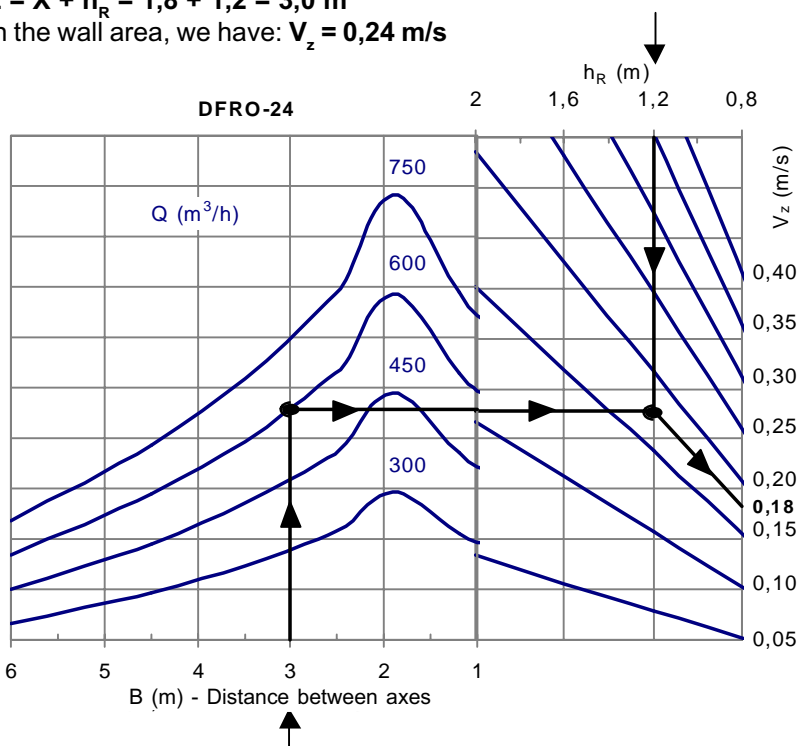
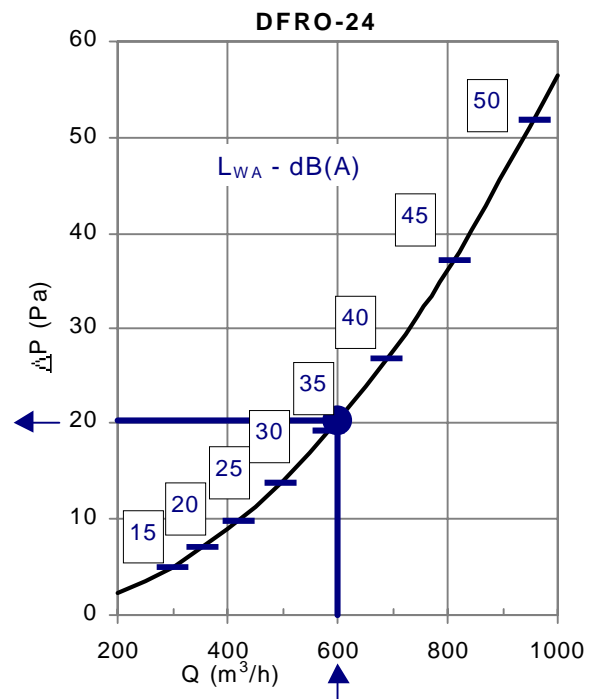

**Note:** The catalogue also includes selection tables for these specific cases.

# DR-RO swirl diffusers

## Basic sizes

There are eight basic slot arrays for the DF-RO, varying from 12 to 48 slots and covering a wide range of air flow rates. Since the diffusers can be integrated into different sizes and types of panel (square, rectangular, round, etc.), **each basic size is coded according to the number of slots it includes.**

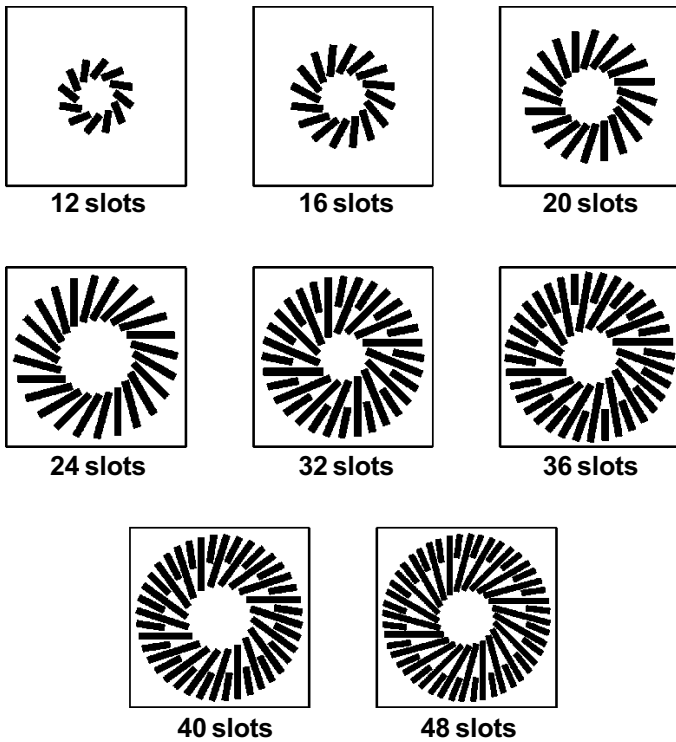

**Square panels for modular false ceiling, installation type: DF-RO. Dimensions and coding.**

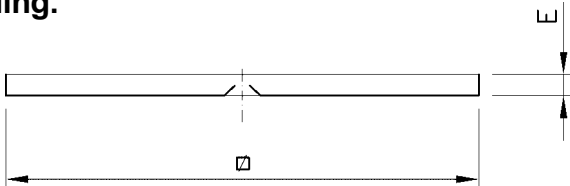

Panel for modular ceiling: DF-RO			
Basic size	Minimum standardized panel		
	Dimensions	Panel code	E
12	294 x 294	30	6
16	394 x 394	40	6
20	494 x 494	50	6
24	594 x 594	60	10
32	594 x 594	60	10
36	623 x 623	62	10
40	670 x 670	67	10
48	795 x 795	80	10

**Square panels for plaster false ceiling, installation type: DF-RO-E. Dimensions and coding.**

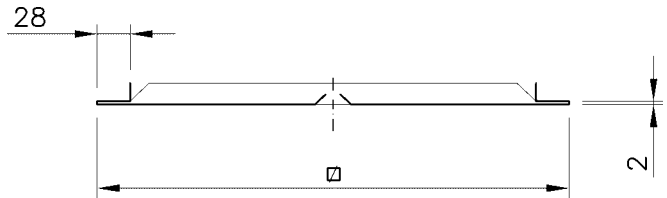

Panel for plaster ceiling: DF-RO-E		
Basic size	Minimum standardized panel	
	Dimensions	Panel code
12	320 x 320	32
16	420 x 420	42
20	520 x 520	52
24	620 x 620	62
32	620 x 620	62
36	645 x 645	64
40	695 x 695	69
48	820 x 820	82

**Note:** This installation model has no sharp edges.

**Plenum with lateral connection for diffusers integrated in square panels, PQ model.**

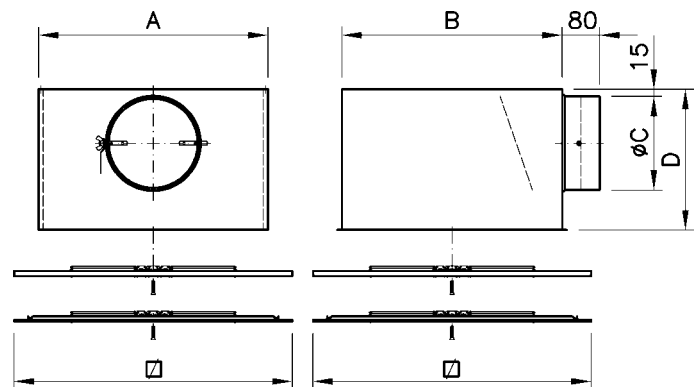

Basic size	A	B	C	D
12	288	270	159	250
16	388	370	199	300
20	488	470	199	300
24	588	570	249	350
32	588	570	249	350
36	616	598	249	350
40	663	645	314*	350
48	788	770	314	410

(\*) In oval model.



## DR-RO swirl diffusers

Round panels for false ceiling, installation model: DF-RO-C. Dimensions and coding

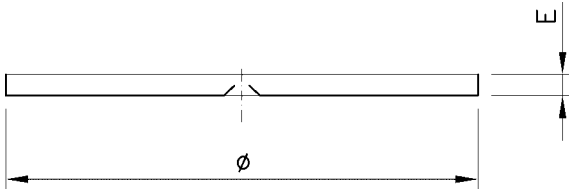

Panel for plaster ceiling: DF-RO-C			
Basic size	Minimum standardized panel		
	Dimensions	Panel code	E
12	Ø 298	30	6
16	Ø 403	40	6
20	Ø 500	50	10
24	Ø 594	60	10
32	Ø 594	60	10
48	Ø 800	80	10

Connection plenum, PC model for diffusers integrated in round panels.

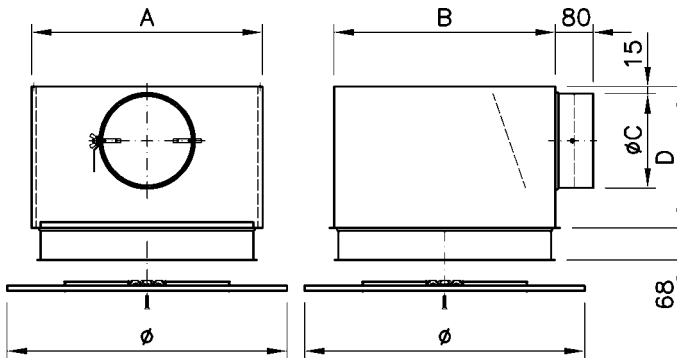

Basic size	A	B	C	D
12	288	270	159	250
16	388	370	199	300
20	488	470	199	300
24	588	570	249	350
32	588	570	249	350
48	788	770	314	410

### Coding for purchase orders. Example

Coding provides a unique description of the model ordered by the customer.

<b>DF-RO</b>	Square panel/Modular ceiling
<b>DF-RO-E</b>	Square panel/Plaster ceiling
<b>DF-RO-C</b>	Round panel

Standard panel finish in white (RAL 9010), other finishes available by special order.

<b>12, 16,... 48</b>	Basic size / N°. of slots
----------------------	---------------------------

Standard deflectors in black (RAL 9005). White (RAL 9010) finishes available by special order.

<b>30, 40,... 80</b>	Panel code <b>DF-RO</b>
<b>32, 42,... 82</b>	Panel code <b>DF-RO-E</b>
<b>30, 40,... 80</b>	Panel code <b>DF-RO-C</b>

Check compatibility with the basic sizes.

<b>PQ</b>	Plenum with lateral connection for <b>DF-RO</b> and <b>DF-RO-E</b>
<b>PQA</b>	Same as above, internally insulated
<b>PC</b>	Plenum with lateral connection for <b>DF-RO-C</b>
<b>PCA</b>	Same as above, internally insulated

Special installation types by special order

<b>RE</b>	Manual damper accessible from false ceiling
<b>RL</b>	Manual damper accessible from room
<b>RM</b>	Damper equipped to allow motorization

Coding example:

**DF-RO-C/2050/PCA/RL**

Description:

Adjustable-blade swirl diffuser, **DF-RO-C** model, size 20, round installation type with diameter 500 mm; insulated plenum with lateral connection and manual damper accessible from the room. Front panel in white (RAL 9010) with deflectors in black (RAL 9005).

# Selection table

## DF-RO (air stream between diffusers)

Q		No. of sbts		DF-RO (air stream between diffusers)																																			
m <sup>3</sup> /h	l/s	B		12			16			20			24			32			40			48																	
		1,2	1,8	2,7	1,2	1,8	2,7	1,2	1,8	2,7	1,2	1,8	2,7	1,2	1,8	2,7	1,2	1,8	2,7	1,2	1,8	2,7	1,2	1,8	2,7														
50	13,9	V <sub>z</sub>	H = 2,7	0,03	0,04	0,03	Example: DF-RO 2460 diffuser (24 slots).  Initial data Q = 650 m <sup>3</sup> /h B = 2,7 m. H = 3,2 m.  Results L <sub>WA</sub> = 38 dB(A) V <sub>z</sub> = 0,18 m/s ΔP <sub>t</sub> = 24 Pa																																
			H = 3,2	0,02	0,02	0,02																																	
			H = 3,8	0,02	0,02	0,01																																	
		ΔP <sub>t</sub> (Pa)	2																																				
		L <sub>WA</sub>	<15																																				
150	41,7	V <sub>z</sub>	H = 2,7	0,11	0,12	0,10	0,09	0,12	0,08	0,08	0,10	0,07																											
			H = 3,2	0,07	0,08	0,06	0,06	0,07	0,05	0,05	0,06	0,05																											
			H = 3,8	0,05	0,05	0,05	0,04	0,05	0,04	0,04	0,04	0,03																											
		ΔP <sub>t</sub> (Pa)	16			4			3																														
		L <sub>WA</sub>	25			<15			<15																														
250	69,4	V <sub>z</sub>	H = 2,7	0,18	0,20	0,17	0,15	0,19	0,13	0,14	0,16	0,12	0,11	0,14	0,11																								
			H = 3,2	0,12	0,13	0,11	0,10	0,12	0,08	0,09	0,10	0,08	0,07	0,09	0,07																								
			H = 3,8	0,08	0,09	0,08	0,07	0,08	0,06	0,06	0,07	0,05	0,05	0,06	0,05																								
		ΔP <sub>t</sub> (Pa)	45			12			7			4																											
		L <sub>WA</sub>	41			29			19			<15																											
350	97,2	V <sub>z</sub>	H = 2,7	0,21	0,27	0,19	0,19	0,22	0,17	0,16	0,19	0,15	0,15	0,17	0,13	0,13	0,16	0,11	0,13	0,14	0,11																		
			H = 3,2	0,13	0,17	0,12	0,12	0,14	0,11	0,10	0,12	0,09	0,09	0,11	0,08	0,08	0,10	0,07	0,08	0,09	0,07																		
			H = 3,8	0,09	0,12	0,08	0,08	0,10	0,07	0,07	0,08	0,07	0,06	0,08	0,06	0,06	0,07	0,05	0,06	0,06	0,05																		
		ΔP <sub>t</sub> (Pa)	24			14			7			6			5			3																					
		L <sub>WA</sub>	39			29			20			15			<15			<15																					
500	138,9	V <sub>z</sub>	H = 2,7	0,30	0,38	0,27	0,27	0,32	0,24	0,22	0,28	0,21	0,21	0,24	0,18	0,19	0,23	0,16	0,18	0,20	0,15	0,17	0,18	0,14															
			H = 3,2	0,19	0,24	0,17	0,17	0,20	0,15	0,14	0,17	0,14	0,13	0,15	0,11	0,12	0,14	0,10	0,11	0,13	0,10	0,11	0,11	0,09															
			H = 3,8	0,13	0,17	0,12	0,12	0,14	0,11	0,10	0,12	0,09	0,09	0,11	0,08	0,08	0,10	0,07	0,08	0,09	0,07	0,08	0,08	0,06															
		ΔP <sub>t</sub> (Pa)	49			29			14			12			11			7			5																		
		L <sub>WA</sub>	50			39			30			26			25			18			<15																		
650	180,6	V <sub>z</sub>	H = 2,7	0,36	0,41	0,31	0,29	0,36	0,28	0,27	0,31	0,24	0,24	0,29	0,21	0,24	0,26	0,20	0,23	0,23	0,19																		
			H = 3,2	0,22	0,26	0,20	0,18	0,23	0,18	0,17	0,20	0,15	0,15	0,18	0,13	0,15	0,16	0,13	0,14	0,15	0,12																		
			H = 3,8	0,16	0,18	0,14	0,13	0,16	0,12	0,12	0,14	0,10	0,11	0,13	0,09	0,10	0,11	0,09	0,10	0,11	0,09	0,10	0,10	0,08															
		ΔP <sub>t</sub> (Pa)	49			24			20			19			12			8																					
		L <sub>WA</sub>	47			38			34			32			26			21																					
800	222,2	V <sub>z</sub>	H = 2,7	0,36	0,44	0,34	0,34	0,38	0,29	0,30	0,36	0,26	0,29	0,32	0,25	0,28	0,29	0,23																					
			H = 3,2	0,23	0,28	0,22	0,21	0,24	0,18	0,19	0,22	0,16	0,18	0,20	0,16	0,17	0,18	0,14																					
			H = 3,8	0,16	0,19	0,15	0,15	0,17	0,13	0,13	0,16	0,11	0,13	0,14	0,11	0,12	0,12	0,10																					
		ΔP <sub>t</sub> (Pa)	36			30			28			18			12																								
		L <sub>WA</sub>	45			40			39			32			27																								
1000	277,8	V <sub>z</sub>	H = 2,7	0,42	0,48	0,36	0,38	0,44	0,33	0,36	0,40	0,31	0,35	0,36	0,29																								
			H = 3,2	0,27	0,30	0,23	0,24	0,28	0,21	0,23	0,25	0,19	0,22	0,22	0,18																								
			H = 3,8	0,19	0,21	0,16	0,16	0,19	0,14	0,16	0,17	0,13	0,15	0,16	0,13																								
		ΔP <sub>t</sub> (Pa)	46			44			29			19																											
		L <sub>WA</sub>	47			45			39			34																											
1250	347,2	V <sub>z</sub>	H = 2,7	0,45	0,50	0,39	0,43	0,45	0,36																														
			H = 3,2	0,29	0,31	0,24	0,27	0,28	0,23																														
			H = 3,8	0,20	0,22	0,17	0,19	0,19	0,16																														
		ΔP <sub>t</sub> (Pa)	45			30																																	
		L <sub>WA</sub>	46			40																																	
1600	444,4	V <sub>z</sub>	H = 2,7																																				
			H = 3,2																																				
			H = 3,8																																				
		ΔP <sub>t</sub> (Pa)	48			30			0,55			0,57			0,46																								
		L <sub>WA</sub>	48			35			0,36			0,29																											
			0,24			0,25			0,20																														
			48																																				

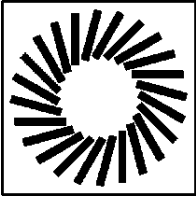

24 slots

**Symbols:**  
 Q = Air flow rate  
 V<sub>z</sub> = Velocity in occupied area, in m/s  
 DP<sub>t</sub> = Total pressure drop, in Pa  
 L<sub>WA</sub> = Sound power, in dB(A)  
 B = Distance between diffuser axes, in m  
 H = Room height, in m



## Selection table DF-RO (air stream toward the wall)

Q		No. of slots	DF-RO (air stream toward the wall)																																				
m³/h		X	12			16			20			24			32			36			40			48															
l/s			0,6	1,5	2,1	0,6	1,5	2,1	0,6	1,5	2,1	0,6	1,5	2,1	0,6	1,5	2,1	0,6	1,5	2,1	0,6	1,5	2,1	0,6	1,5	2,1													
50	13,9	V <sub>z</sub>	H = 2,7	0,08	0,05	0,04	<p><b>Example: DF-RO 3260 diffuser (32 slots).</b></p> <p><b>Initial data</b> Q = 800 m³/h B = 2,1 m. H = 3,8 m.</p> <p><b>Results</b> L<sub>WA</sub> = 40 dB(A) V<sub>z</sub> = 0,20 m/s ΔPt = 30 Pa</p>																																
			H = 3,2	0,06	0,04	0,04																																	
			H = 3,8	0,05	0,04	0,03																																	
		ΔP <sub>t</sub>	2																																				
		L <sub>WA</sub>	<15																																				
150	41,7	V <sub>z</sub>	H = 2,7	0,25	0,16	0,13	0,18	0,11	0,09	0,14	0,09	0,07																											
			H = 3,2	0,19	0,13	0,11	0,14	0,09	0,08	0,11	0,07	0,06																											
			H = 3,8	0,15	0,11	0,09	0,11	0,08	0,07	0,08	0,06	0,05																											
		ΔP <sub>t</sub>	16			4			3																														
		L <sub>WA</sub>	25			<15			<15																														
250	69,4	V <sub>z</sub>	H = 2,7	0,42	0,26	0,21	0,31	0,19	0,15	0,24	0,15	0,12	0,20	0,12	0,10																								
			H = 3,2	0,32	0,22	0,18	0,23	0,16	0,13	0,18	0,12	0,10	0,15	0,10	0,08																								
			H = 3,8	0,24	0,18	0,16	0,18	0,13	0,11	0,14	0,10	0,09	0,11	0,08	0,07																								
		ΔP <sub>t</sub>	45			12			7			4																											
		L <sub>WA</sub>	41			29			19			<15																											
350	97,2	V <sub>z</sub>	H = 2,7	0,43	0,27	0,21	0,33	0,21	0,17	0,28	0,17	0,14	0,24	0,15	0,12	0,23	0,14	0,12	0,22	0,14	0,11																		
			H = 3,2	0,32	0,22	0,18	0,23	0,16	0,13	0,18	0,12	0,10	0,15	0,10	0,08	0,17	0,12	0,10	0,16	0,11	0,09																		
			H = 3,8	0,25	0,18	0,16	0,19	0,14	0,12	0,16	0,12	0,10	0,14	0,10	0,09	0,13	0,10	0,08	0,13	0,09	0,08																		
		ΔP <sub>t</sub>	24			14			7			6			5			3																					
		L <sub>WA</sub>	39			29			20			15			<15			<15																					
500	138,9	V <sub>z</sub>	H = 2,7	0,61	0,38	0,31	0,48	0,30	0,24	0,39	0,25	0,20	0,35	0,22	0,17	0,33	0,21	0,16	0,31	0,19	0,16	0,30	0,19	0,15															
			H = 3,2	0,46	0,32	0,26	0,36	0,25	0,20	0,29	0,20	0,17	0,26	0,18	0,15	0,25	0,17	0,14	0,23	0,16	0,13	0,22	0,15	0,13															
			H = 3,8	0,35	0,26	0,22	0,27	0,20	0,17	0,23	0,17	0,14	0,20	0,15	0,13	0,19	0,14	0,12	0,18	0,13	0,11	0,17	0,13	0,11															
		ΔP <sub>t</sub>	49			29			14			12			11			7			5																		
		L <sub>WA</sub>	50			39			30			26			25			18			<15																		
650	180,6	V <sub>z</sub>	H = 2,7	0,62	0,39	0,31	0,51	0,32	0,26	0,45	0,28	0,23	0,43	0,27	0,21	0,40	0,25	0,20	0,39	0,24	0,19																		
			H = 3,2	0,46	0,32	0,26	0,38	0,26	0,22	0,34	0,23	0,19	0,32	0,22	0,18	0,30	0,21	0,17	0,29	0,20	0,17																		
			H = 3,8	0,36	0,26	0,23	0,29	0,22	0,19	0,26	0,19	0,17	0,25	0,18	0,16	0,23	0,17	0,15	0,22	0,17	0,14																		
		ΔP <sub>t</sub>	49			24			20			19			12			8																					
		L <sub>WA</sub>	47			38			34			32			26			21																					
800	222,2	V <sub>z</sub>	H = 2,7	0,63	0,39	0,31	0,56	0,35	0,28	0,53	0,33	0,26	0,50	0,31	0,25	0,48	0,30	0,24																					
			H = 3,2	0,47	0,33	0,27	0,42	0,29	0,24	0,39	0,27	0,23	0,37	0,26	0,21	0,36	0,25	0,20																					
			H = 3,8	0,36	0,27	0,23	0,32	0,24	0,20	0,30	0,23	0,19	0,29	0,21	0,18	0,27	0,20	0,17																					
		ΔP <sub>t</sub>	36			30			28			18			12																								
		L <sub>WA</sub>	45			40			39			32			27																								
1000	277,8	V <sub>z</sub>	H = 2,7	0,70	0,43	0,35	0,66	0,41	0,33	0,62	0,39	0,31	0,60	0,37	0,30																								
			H = 3,2	0,52	0,36	0,30	0,49	0,34	0,28	0,47	0,32	0,27	0,45	0,31	0,26																								
			H = 3,8	0,40	0,30	0,25	0,38	0,28	0,24	0,36	0,27	0,23	0,34	0,26	0,22																								
		ΔP <sub>t</sub>	46			44			29			19																											
		L <sub>WA</sub>	47			45			39			34																											
1250	347,2	V <sub>z</sub>	H = 2,7	0,78	0,48	0,39	0,74	0,47	0,37																														
			H = 3,2	0,58	0,40	0,33	0,56	0,39	0,32																														
			H = 3,8	0,45	0,33	0,28	0,43	0,32	0,27																														
		ΔP <sub>t</sub>	45			30																																	
		L <sub>WA</sub>	46			40																																	
1600	444,4	V <sub>z</sub>	H = 2,7	0,95	0,60	0,48																																	
			H = 3,2	0,71	0,49	0,41																																	
			H = 3,8	0,55	0,41	0,35																																	
		ΔP <sub>t</sub>	48																																				
		L <sub>WA</sub>	48																																				

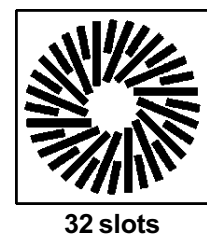

**Symbols:**  
 Q = Air flow rate  
 V<sub>z</sub> = Velocity in occupied area, in m/s  
 DP<sub>t</sub> = Total pressure drop, in Pa  
 L<sub>WA</sub> = Sound power, in dB(A)  
 B = Distance between diffuser axes, in m  
 H = Room height, in m

# Selection graphs for DF-RO 12 and 16 slots

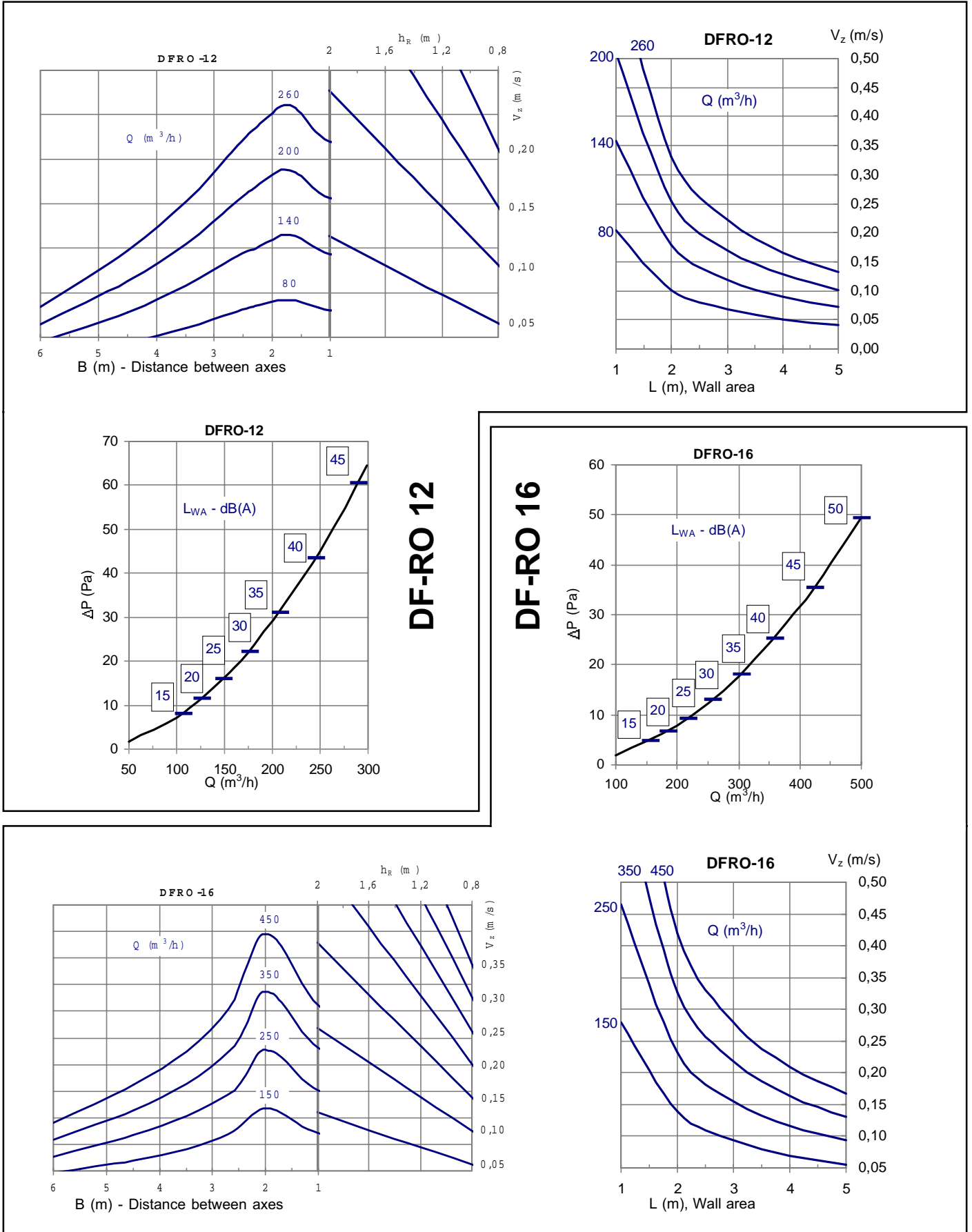

# Selection graphs for DF-RO 20 and 24 slots

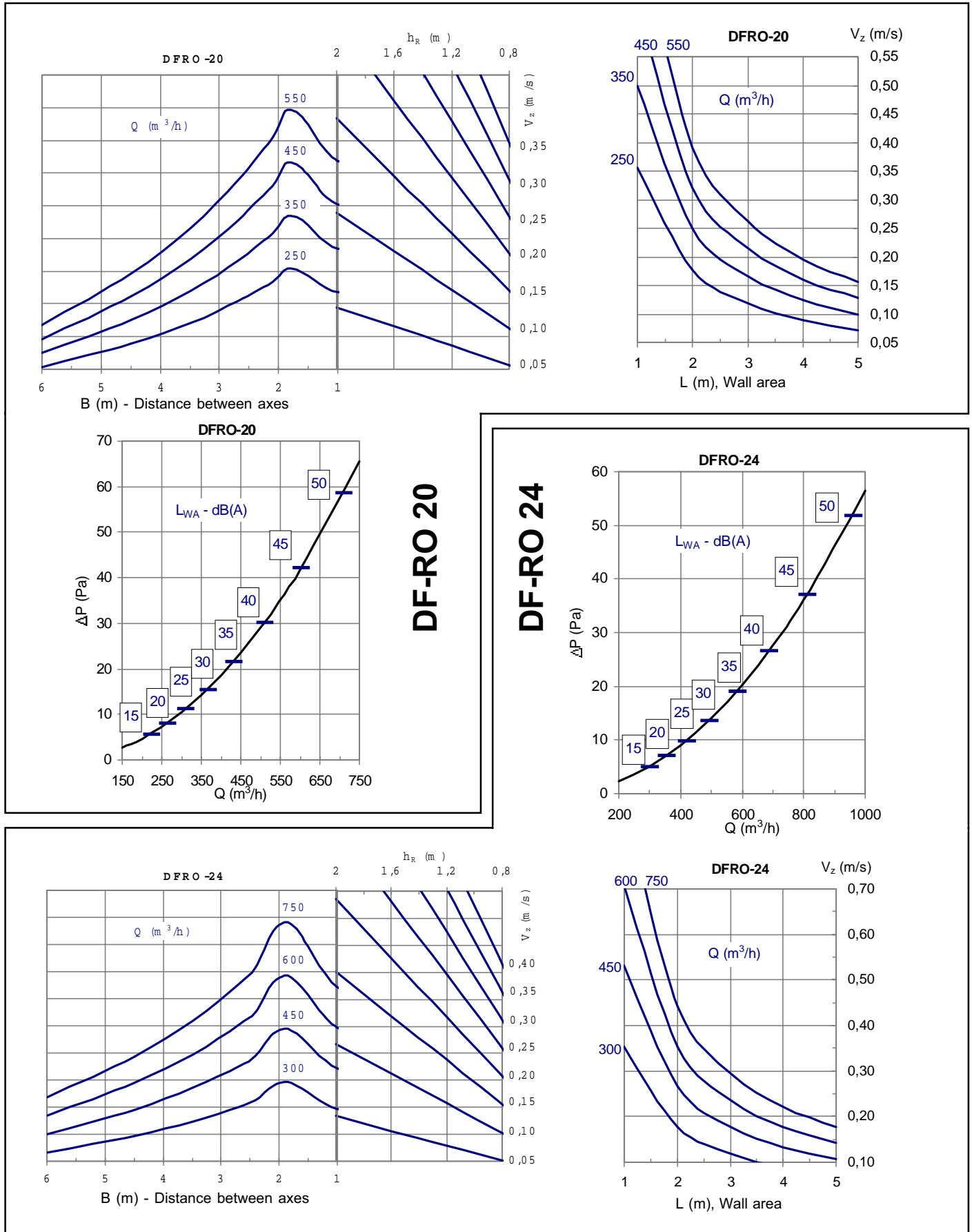

# Selection graphs for DF-RO 32 and 36 slots

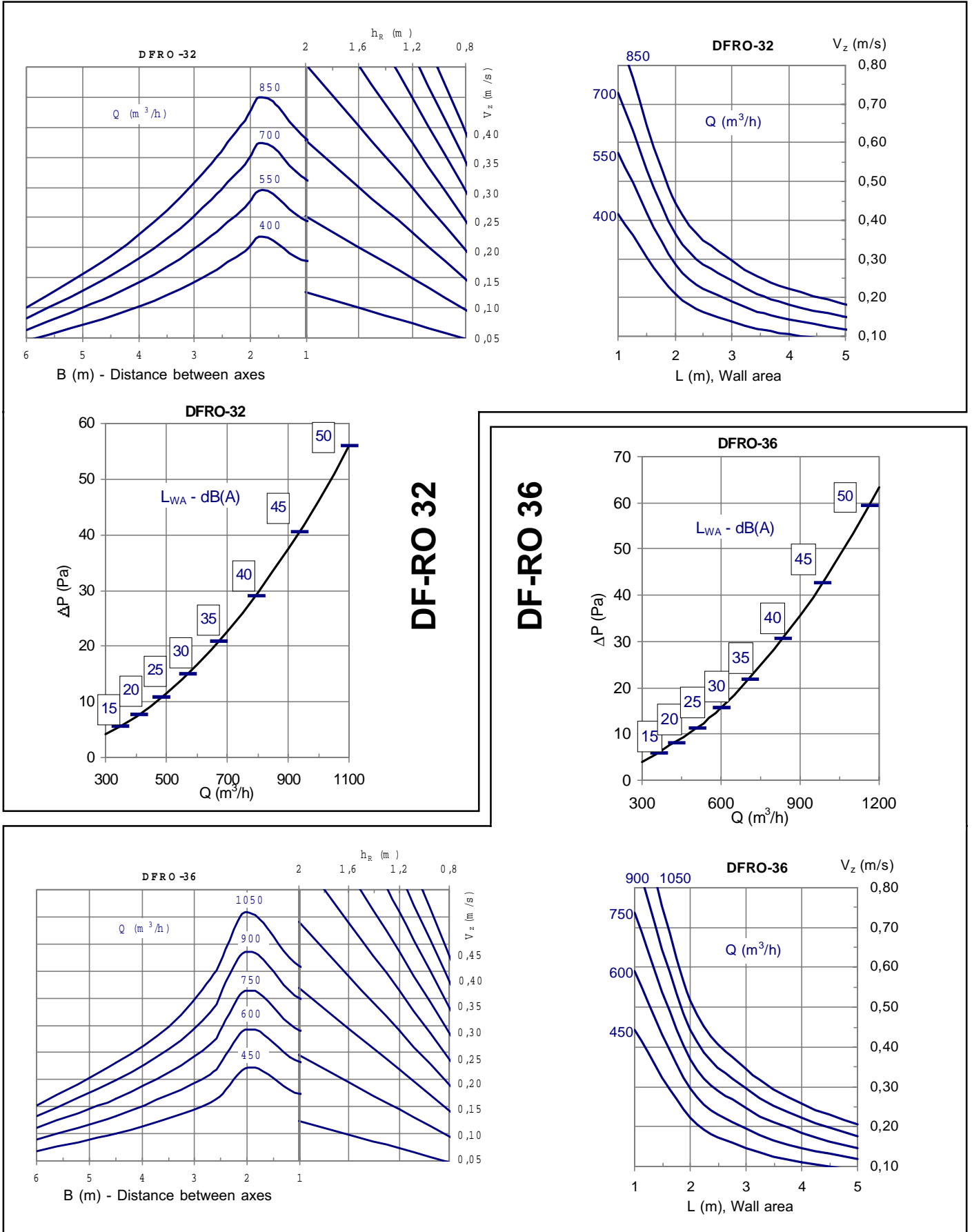

# Selection graphs for DF-RO 40 and 48 slots

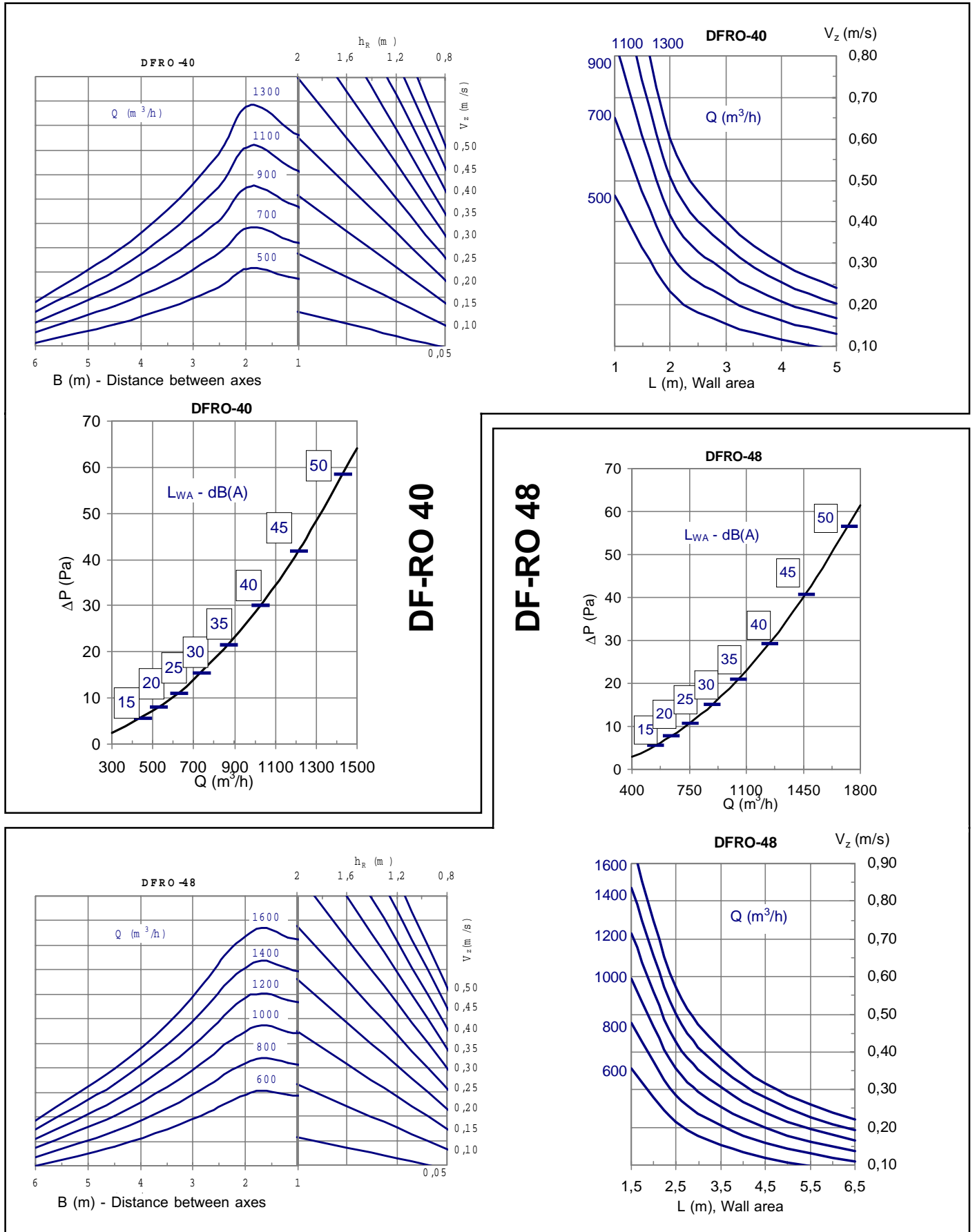

# DF-RA swirl diffusers

## Basic sizes

There are eight basic slot arrays for the DF-RA, varying from 12 to 48 slots and covering a wide range of air flow rates. Since the diffusers can be integrated into different sizes and types of panel (square, rectangular, round, etc.), **each basic size is coded according to the number of slots it includes.**

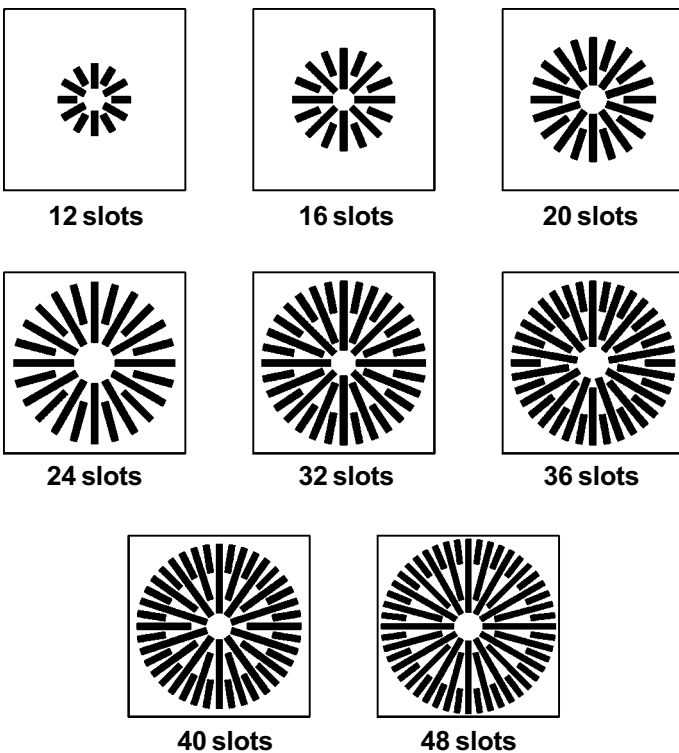

**Square panels for modular false ceiling, installation type: DF-RA. Dimensions and coding.**

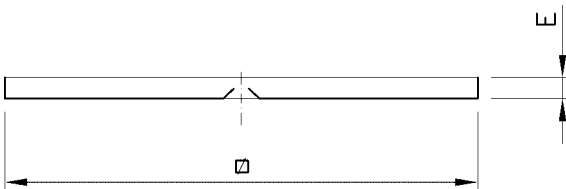

Panel for modular ceiling: DF-RA			
Basic size	Minimum standardized panel		
	Dimensions	Panel code	E
12	294 x 294	30	6
16	394 x 394	40	6
20	494 x 494	50	6
24	594 x 594	60	10
32	594 x 594	60	10
36	623 x 623	62	10
40	670 x 670	67	10
48	795 x 795	80	10

**Square panels for plaster false ceiling, installation type: DF-RA-E. Dimensions and coding**

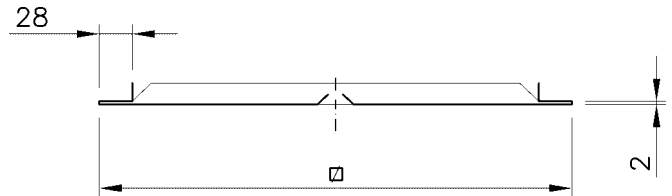

Panel for plaster ceiling: DF-RA-E		
Basic size	Minimum standardized panel	
	Dimensions	Panel code
12	320 x 320	32
16	420 x 420	42
20	520 x 520	52
24	620 x 620	62
32	620 x 620	62
36	645 x 645	64
40	695 x 695	69
48	820 x 820	82

**Note:** This installation model has no sharp edges.

**Plenum with lateral connection for diffusers integrated in square panels, PQ model**

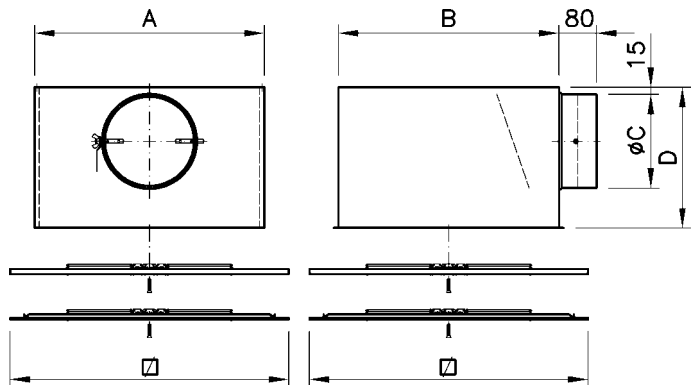

Basic size	A	B	C	D
12	288	270	159	250
16	388	370	199	300
20	488	470	199	300
24	588	570	249	350
32	588	570	249	350
36	616	598	249	350
40	663	645	314*	350
48	788	770	314	410

(\*) In oval model.

## DF-RA swirl diffusers

Round panels for false ceiling, installation model: DF-RA-C. Dimensions and coding.

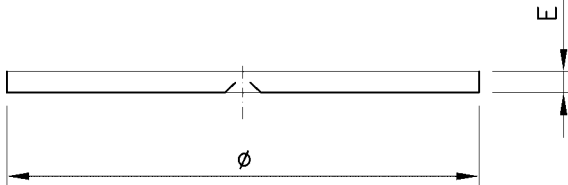

Panel for plaster ceiling: DF-RA-C			
Basic size	Minimum standardized panel		
	Dimensions	Panel code	E
12	Ø 298	30	6
16	Ø 403	40	6
20	Ø 500	50	10
24	Ø 594	60	10
32	Ø 594	60	10
48	Ø 800	80	10

Connection plenum, PC model for diffusers integrated in round panels

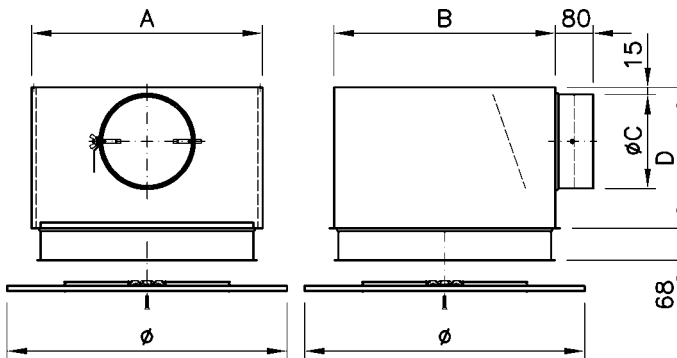

Basic size	A	B	C	D
12	288	270	159	250
16	388	370	199	300
20	488	470	199	300
24	588	570	249	350
32	588	570	249	350
48	788	770	314	410

### Coding for purchase orders. Example

Coding provides a unique description of the model ordered by the customer.

<b>DF-RA</b>	Square panel/Modular ceiling
<b>DF-RA-E</b>	Square panel/Plaster ceiling
<b>DF-RA-C</b>	Round panel

Standard panel finish in white (RAL 9010), other finishes available by special order.

**12, 16,... 48** Basic size / N°. of slots

Standard deflectors in black (RAL 9005). White (RAL 9010) finishes available by special order.

<b>30, 40,... 80</b>	Panel code <b>DF-RA</b>
<b>32, 42,... 82</b>	Panel code <b>DF-RA-E</b>
<b>30, 40,... 80</b>	Panel code <b>DF-RA-C</b>

Check compatibility with the basic sizes.

<b>PQ</b>	Plenum with lateral connection for <b>DF-RA</b> and <b>DF-RA-E</b>
<b>PQA</b>	Same as above, internally insulated
<b>PC</b>	Plenum with lateral connection for <b>DF-RA-C</b>
<b>PCA</b>	Same as above, internally insulated

Special installations by special order

<b>RE</b>	Manual damper accessible from false ceiling.
<b>RL</b>	Manual damper accessible from room.
<b>RM</b>	Damper equipped to allow motorization.

Coding example:

**DF-RA/1660/ PQ/RE**

Description:

Adjustable-blade swirl diffuser, **DF-RA** model, size 16, in square panel of 594 x 594; plenum with lateral connection and manual damper accessible from room. Front panel in white (RAL 9010) with deflectors in black (RAL 9005)



# Selection table

## DF-RA (air stream between diffusers)

Q		No. of slots		DF-RA (air stream between diffusers)																																																		
m <sup>3</sup> /h	l/s	B	12			16			20			24			32			36			40			48																														
			1,2	1,8	2,7	1,2	1,8	2,7	1,2	1,8	2,7	1,2	1,8	2,7	1,2	1,8	2,7	1,2	1,8	2,7	1,2	1,8	2,7	1,2	1,8	2,7																												
50	13,9	V <sub>z</sub>	H = 2,7	0,03	0,04	0,03	Example: DF-RA 2460 diffuser (24 slots).  Initial data Q = 650 m <sup>3</sup> /h B = 2,7 m. H = 2,7 m.  Results L <sub>WA</sub> = 37 dB(A) V <sub>z</sub> = 0,27 m/s ΔP <sub>t</sub> = 23 Pa																																															
			H = 3,2	0,02	0,02	0,02																																																
			H = 3,8	0,02	0,02	0,01																																																
		ΔP <sub>t</sub> (Pa)	2																																																			
		L <sub>WA</sub>	<15																																																			
150	41,7	V <sub>z</sub>	H = 2,7	0,11	0,12	0,10																									0,09	0,11	0,08	0,08	0,09	0,07																		
			H = 3,2	0,07	0,08	0,06																									0,06	0,07	0,05	0,05	0,06	0,04																		
			H = 3,8	0,05	0,05	0,05																									0,04	0,05	0,03	0,03	0,04	0,03																		
		ΔP <sub>t</sub> (Pa)	16			4																									3																							
		L <sub>WA</sub>	25			<15																									<15																							
250	69,4	V <sub>z</sub>	H = 2,7	0,18	0,20	0,17	0,14	0,18	0,13	0,13	0,15	0,12	0,11	0,13	0,10																																							
			H = 3,2	0,12	0,13	0,11	0,09	0,12	0,08	0,08	0,10	0,07	0,07	0,08	0,07																																							
			H = 3,8	0,08	0,09	0,08	0,06	0,08	0,06	0,06	0,07	0,05	0,05	0,06	0,05																																							
		ΔP <sub>t</sub> (Pa)	45			12			7			3																																										
		L <sub>WA</sub>	41			29			19			<15																																										
350	97,2	V <sub>z</sub>	H = 2,7	0,20	0,26	0,18	0,18	0,21	0,16	0,15	0,19	0,15	0,14	0,17	0,12	0,13	0,16	0,11	0,12	0,13	0,10																																	
			H = 3,2	0,13	0,16	0,11	0,12	0,14	0,10	0,10	0,12	0,09	0,09	0,11	0,08	0,08	0,10	0,07	0,08	0,08	0,06																																	
			H = 3,8	0,09	0,11	0,08	0,08	0,09	0,07	0,07	0,08	0,06	0,06	0,07	0,05	0,06	0,07	0,05	0,05	0,06	0,04																																	
		ΔP <sub>t</sub> (Pa)	23			14			7			6			5			3																																				
		L <sub>WA</sub>	38			28			20			16			<15			<15																																				
500	138,9	V <sub>h,r</sub>	H = 2,7	0,29	0,36	0,25	0,26	0,31	0,23	0,22	0,27	0,21	0,20	0,24	0,18	0,18	0,22	0,16	0,17	0,19	0,15	0,16	0,17	0,13																														
			H = 3,2	0,18	0,23	0,16	0,17	0,19	0,15	0,14	0,17	0,13	0,13	0,15	0,11	0,11	0,14	0,10	0,11	0,12	0,09	0,10	0,11	0,08																														
			H = 3,8	0,13	0,16	0,11	0,12	0,13	0,10	0,10	0,12	0,09	0,09	0,10	0,08	0,08	0,10	0,07	0,07	0,08	0,06	0,06	0,07	0,06																														
		ΔP <sub>t</sub> (Pa)	47			28			13			11			10			6			4																																	
		L <sub>WA</sub>	48			38			30			26			24			18			<15																																	
650	180,6	V <sub>z</sub>	H = 2,7	0,34	0,40	0,30	0,28	0,35	0,27	0,27	0,30	0,23	0,24	0,28	0,21	0,22	0,24	0,19	0,21	0,22	0,18	0,21	0,22	0,18																														
			H = 3,2	0,22	0,25	0,19	0,18	0,22	0,17	0,17	0,19	0,15	0,15	0,18	0,13	0,14	0,15	0,12	0,13	0,14	0,11	0,12	0,13	0,10																														
			H = 3,8	0,15	0,18	0,13	0,12	0,15	0,12	0,12	0,13	0,10	0,10	0,12	0,09	0,10	0,11	0,08	0,09	0,10	0,08	0,09	0,10	0,08																														
		ΔP <sub>t</sub> (Pa)	48			23			19			18			11			8																																				
		L <sub>WA</sub>	46			37			34			32			26			21																																				
800	222,2	V <sub>z</sub>	H = 2,7	0,35	0,43	0,33	0,33	0,37	0,28	0,29	0,35	0,25	0,27	0,30	0,23	0,26	0,27	0,22	0,23	0,26	0,21	0,22	0,23	0,19																														
			H = 3,2	0,22	0,27	0,21	0,21	0,24	0,18	0,18	0,22	0,16	0,17	0,19	0,15	0,16	0,17	0,15	0,16	0,17	0,14																																	
			H = 3,8	0,15	0,19	0,15	0,14	0,16	0,12	0,13	0,15	0,11	0,12	0,13	0,10	0,11	0,12	0,10	0,11	0,12	0,09																																	
		ΔP <sub>t</sub> (Pa)	34			29			27			16			11																																							
		L <sub>WA</sub>	43			39			37			32			27																																							
1000	277,8	V <sub>z</sub>	H = 2,7	0,41	0,46	0,35	0,37	0,43	0,32	0,34	0,38	0,29	0,33	0,34	0,27	0,33	0,34	0,27	0,33	0,34	0,27	0,33	0,34	0,27																														
			H = 3,2	0,26	0,29	0,22	0,23	0,27	0,20	0,22	0,24	0,18	0,20	0,22	0,18	0,20	0,21	0,17																																				
			H = 3,8	0,18	0,20	0,15	0,16	0,19	0,14	0,15	0,16	0,13	0,14	0,15	0,12	0,14	0,15	0,12																																				
		ΔP <sub>t</sub> (Pa)	45			41			25			18																																										
		L <sub>WA</sub>	46			44			38			33																																										
1250	347,2	V <sub>z</sub>	H = 2,7	0,43	0,47	0,36	0,41	0,42	0,34																																													
			H = 3,2	0,27	0,30	0,23	0,26	0,26	0,21																																													
			H = 3,8	0,19	0,20	0,16	0,18	0,18	0,15																																													
		ΔP <sub>t</sub> (Pa)	40			28																																																
		L <sub>WA</sub>	44			39																																																
1600	444,4	V <sub>z</sub>	H = 2,7	0,52	0,54	0,44																																																
			H = 3,2	0,33	0,34	0,28																																																
			H = 3,8	0,23	0,23	0,19																																																
		ΔP <sub>t</sub> (Pa)	46																																																			
		L <sub>WA</sub>	46																																																			

**Symbols:**  
 Q = Air flow  
 V<sub>z</sub> = Velocity in occupied area, in m/s  
 DP<sub>t</sub> = Total pressure drop, in Pa  
 L<sub>WA</sub> = Sound power, in dB(A)  
 B = Distance between diffuser axes, in m  
 H = Room height, in m



## Selection table DF-RA (air stream toward the wall)

DF-RA (air stream toward the wall)																													
Q		No. of sbts	12			16			20			24			32			36			40			48					
m³/h	l/s	X	0,6	1,5	2,1	0,6	1,5	2,1	0,6	1,5	2,1	0,6	1,5	2,1	0,6	1,5	2,1	0,6	1,5	2,1	0,6	1,5	2,1	0,6	1,5	2,1			
50	13,9	V <sub>z</sub>	H = 2,7	0,08	0,05	0,04	<p><b>Example: DF-RA 3662 diffuser (36 slots).</b></p> <p><b>Initial data</b> Q = 1000 m³/h B = 2,1 m. H = 3,8 m.</p> <p><b>Results</b> L<sub>WA</sub> = 44 dB(A) V<sub>z</sub> = 0,23 m/s ΔPt = 41 Pa</p>																						
			H = 3,2	0,06	0,04	0,04																							
			H = 3,8	0,05	0,04	0,03																							
		ΔP <sub>t</sub>	2																										
		L <sub>WA</sub>	<15																										
150	41,7	V <sub>z</sub>	H = 2,7	0,25	0,16	0,13	0,17	0,11	0,09	0,14	0,09	0,07																	
			H = 3,2	0,19	0,13	0,11	0,13	0,09	0,07	0,11	0,07	0,06																	
			H = 3,8	0,15	0,11	0,09	0,10	0,07	0,06	0,08	0,06	0,05																	
		ΔP <sub>t</sub>	16			4			3																				
		L <sub>WA</sub>	25			<15			<15																				
250	69,4	V <sub>z</sub>	H = 2,7	0,42	0,26	0,21	0,28	0,18	0,14	0,24	0,15	0,12	0,19	0,12	0,10														
			H = 3,2	0,32	0,22	0,18	0,21	0,15	0,12	0,18	0,12	0,10	0,14	0,10	0,08														
			H = 3,8	0,24	0,18	0,16	0,16	0,12	0,10	0,14	0,10	0,09	0,11	0,08	0,07														
		ΔP <sub>t</sub>	45			12			7			3																	
		L <sub>WA</sub>	41			29			19			<15																	
350	97,2	V <sub>z</sub>	H = 2,7	0,40	0,25	0,20	0,33	0,21	0,16	0,27	0,17	0,13	0,24	0,15	0,12	0,22	0,14	0,11	0,20	0,13	0,10								
			H = 3,2	0,30	0,21	0,17	0,25	0,17	0,14	0,20	0,14	0,11	0,18	0,12	0,10	0,17	0,11	0,09	0,15	0,11	0,09								
			H = 3,8	0,23	0,17	0,15	0,19	0,14	0,12	0,15	0,11	0,10	0,14	0,10	0,09	0,13	0,09	0,08	0,12	0,09	0,07								
		ΔP <sub>t</sub>	23			14			7			6			5			3											
		L <sub>WA</sub>	38			28			20			16			<15			<15											
500	138,9	V <sub>z</sub>	H = 2,7	0,57	0,35	0,28	0,47	0,29	0,24	0,38	0,24	0,19	0,34	0,21	0,17	0,31	0,20	0,16	0,29	0,18	0,15	0,28	0,18	0,14					
			H = 3,2	0,43	0,29	0,24	0,35	0,24	0,20	0,29	0,20	0,16	0,25	0,17	0,14	0,24	0,16	0,13	0,22	0,15	0,13	0,21	0,15	0,12					
			H = 3,8	0,33	0,24	0,21	0,27	0,20	0,17	0,22	0,16	0,14	0,19	0,14	0,12	0,18	0,13	0,12	0,17	0,13	0,11	0,16	0,12	0,10					
		ΔP <sub>t</sub>	47			28			13			11			10			6			4								
		L <sub>WA</sub>	48			38			30			26			24			18			<15								
650	180,6	V <sub>z</sub>	H = 2,7	0,61	0,38	0,31	0,50	0,31	0,25	0,44	0,27	0,22	0,41	0,26	0,20	0,38	0,24	0,19	0,37	0,23	0,18	0,37	0,23	0,18					
			H = 3,2	0,46	0,32	0,26	0,37	0,26	0,21	0,33	0,23	0,19	0,31	0,21	0,18	0,28	0,20	0,16	0,27	0,19	0,16								
			H = 3,8	0,35	0,26	0,22	0,29	0,21	0,18	0,25	0,19	0,16	0,24	0,18	0,15	0,22	0,16	0,14	0,21	0,16	0,13								
		ΔP <sub>t</sub>	48			23			19			18			11			8											
		L <sub>WA</sub>	46			37			34			32			26			21											
800	222,2	V <sub>z</sub>	H = 2,7	0,61	0,38	0,31	0,54	0,34	0,27	0,50	0,31	0,25	0,47	0,29	0,23	0,45	0,28	0,22	0,45	0,28	0,22								
			H = 3,2	0,46	0,32	0,26	0,40	0,28	0,23	0,38	0,26	0,22	0,35	0,24	0,20	0,34	0,23	0,19											
			H = 3,8	0,35	0,26	0,22	0,31	0,23	0,20	0,29	0,22	0,18	0,27	0,20	0,17	0,26	0,19	0,16											
		ΔP <sub>t</sub>	34			29			27			16			11														
		L <sub>WA</sub>	43			39			37			32			27														
1000	277,8	V <sub>z</sub>	H = 2,7	0,67	0,42	0,34	0,63	0,39	0,31	0,58	0,37	0,29	0,56	0,35	0,28														
			H = 3,2	0,51	0,35	0,29	0,47	0,33	0,27	0,44	0,30	0,25	0,42	0,29	0,24														
			H = 3,8	0,39	0,29	0,25	0,36	0,27	0,23	0,34	0,25	0,21	0,32	0,24	0,21														
		ΔP <sub>t</sub>	45			41			25			18																	
		L <sub>WA</sub>	46			44			38			33																	
1250	347,2	V <sub>z</sub>	H = 2,7	0,73	0,46	0,37	0,70	0,44	0,35																				
			H = 3,2	0,55	0,38	0,31	0,53	0,36	0,30																				
			H = 3,8	0,42	0,31	0,27	0,41	0,30	0,26																				
		ΔP <sub>t</sub>	40			28																							
		L <sub>WA</sub>	44			39																							
1600	444,4	V <sub>z</sub>	H = 2,7	0,90	0,56	0,45																							
			H = 3,2	0,67	0,47	0,39																							
			H = 3,8	0,52	0,39	0,33																							
		ΔP <sub>t</sub>	46																										
		L <sub>WA</sub>	46																										

**Symbols:**  
 Q = Air flow  
 V<sub>z</sub> = Velocity in occupied area, in m/s  
 DP<sub>t</sub> = Total pressure drop, in Pa  
 L<sub>WA</sub> = Sound power, in dB(A)  
 B = Distance between diffuser axes, in m  
 H = Room height, in m

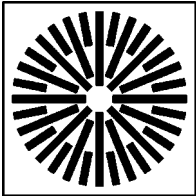

**36 slots**

# Selection graphs for DF-RA 12 and 16 slots

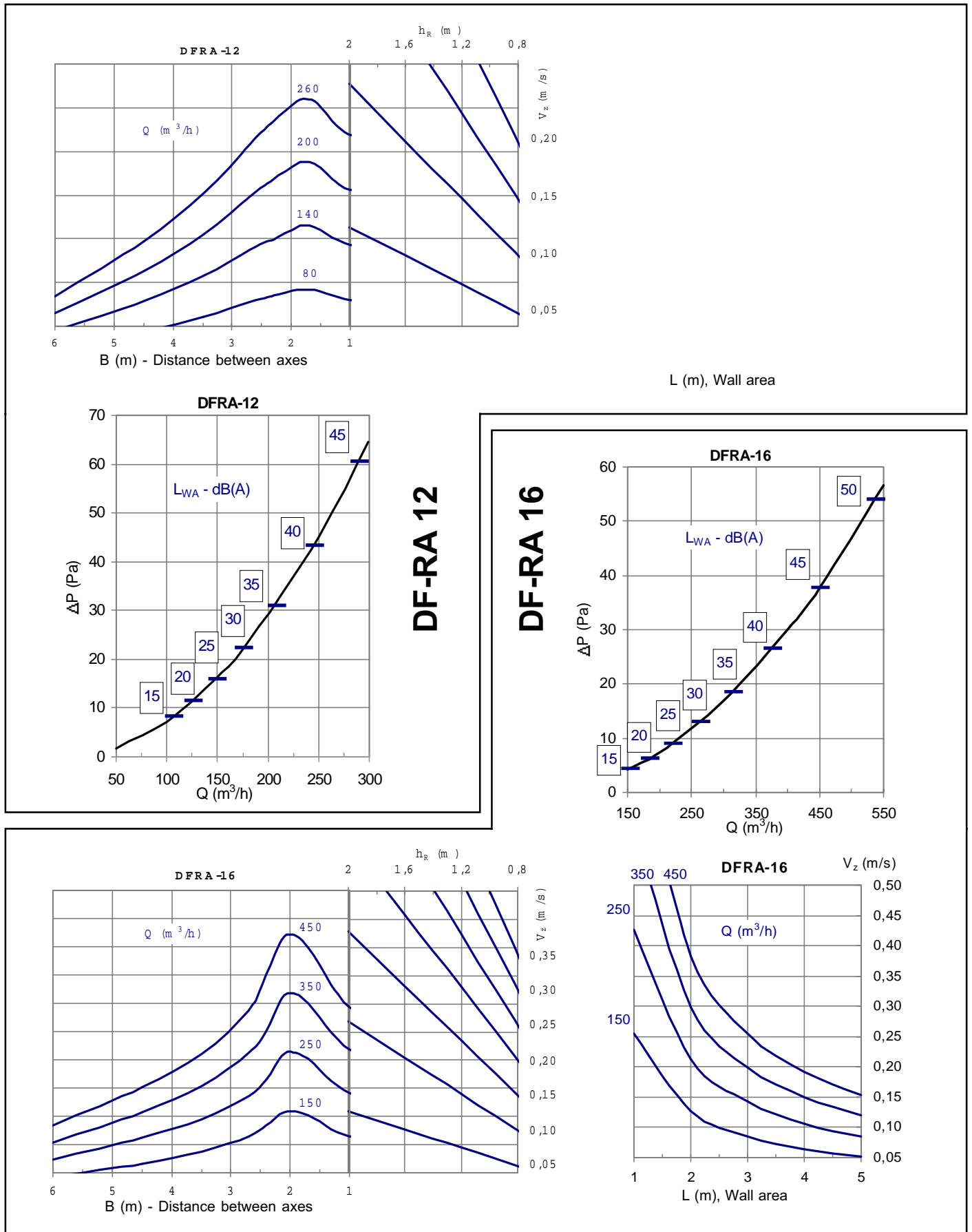

## Selection graphs for DF-RA 20 and 24 slots

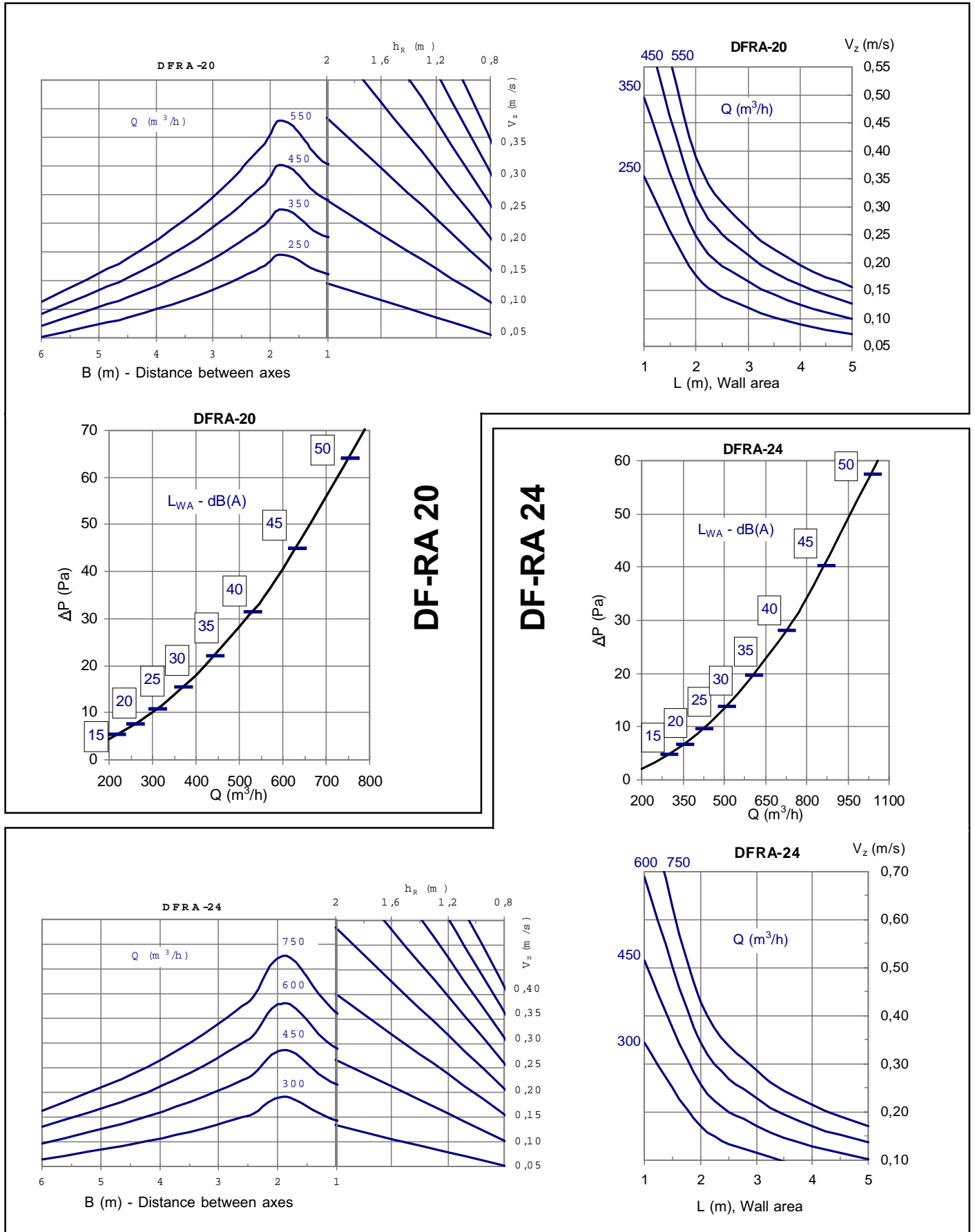

# Selection graphs for DF-RA 32 and 36 slots

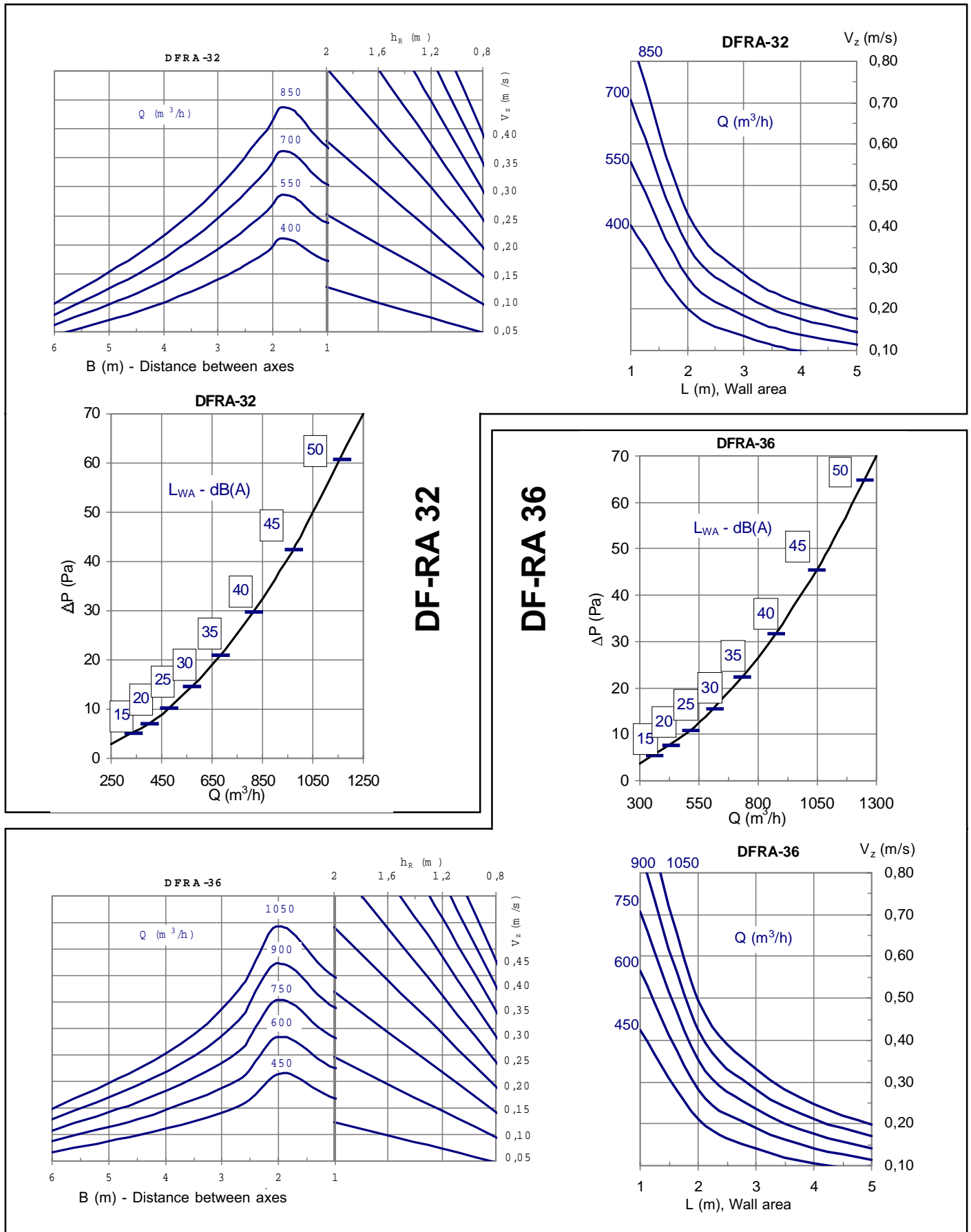

# Selection graphs for DF-RA 40 and 48 slots

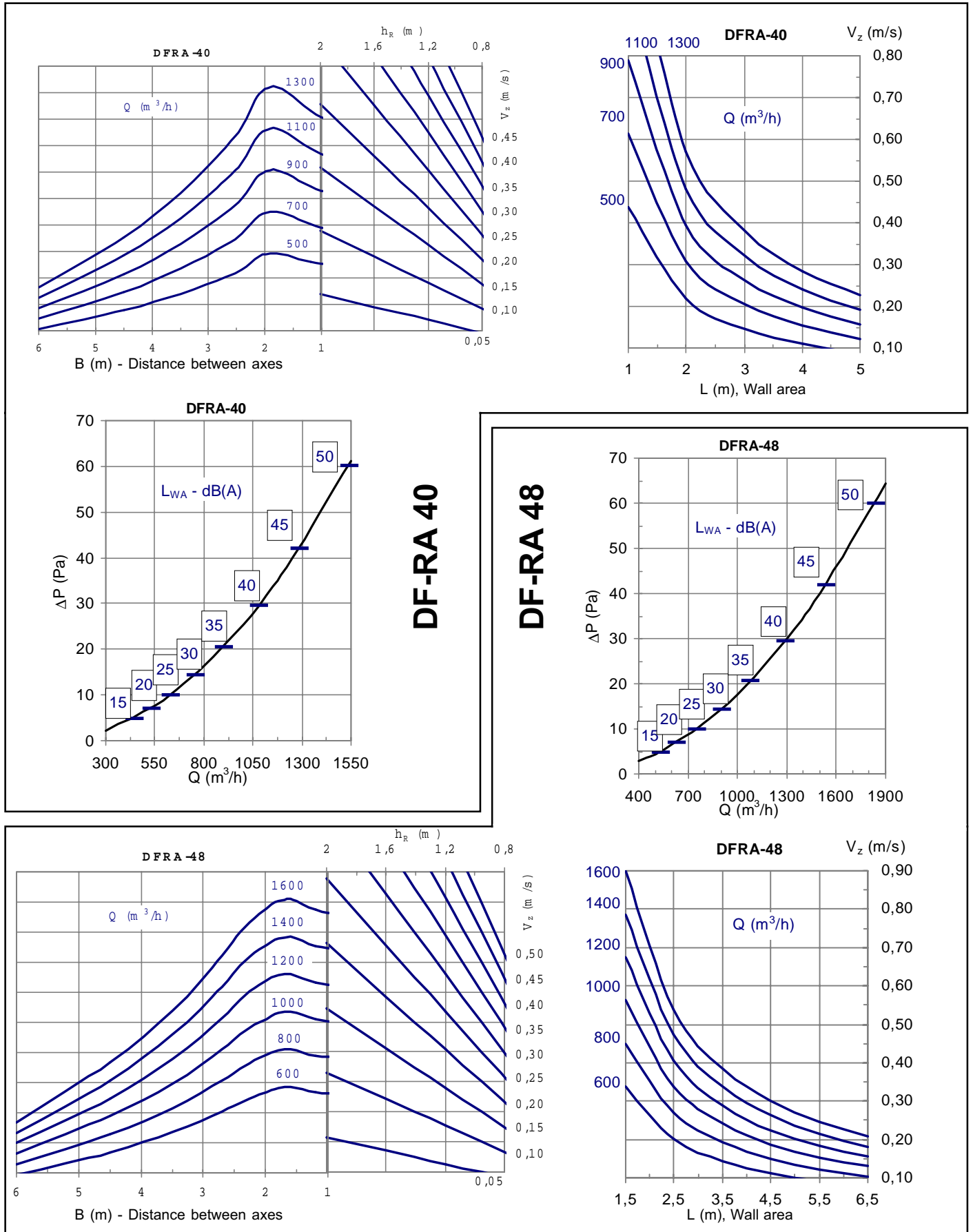

# DF-RQ swirl diffusers

## Basic sizes

There are four basic slot arrays for the **DF-RQ**, varying from 28 to 48 slots and covering a wide range of air flow rates. Since the diffusers can be integrated into different sizes and types of panel (square, rectangular, round, etc.), **each basic size is coded according to the number of slots it includes.**

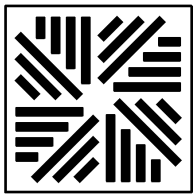

28 slots

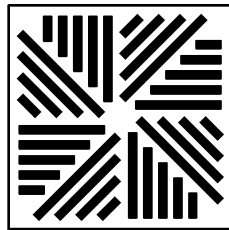

36 slots

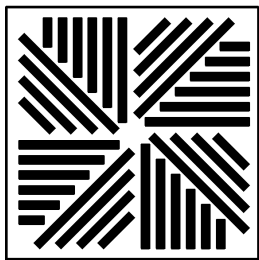

40 slots

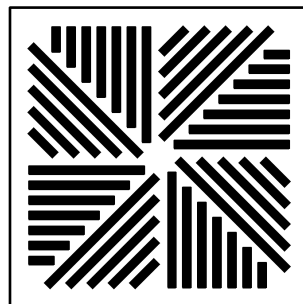

48 slots

**Square panels for modular false ceiling, installation type: DF-RQ. Dimensions and coding.**

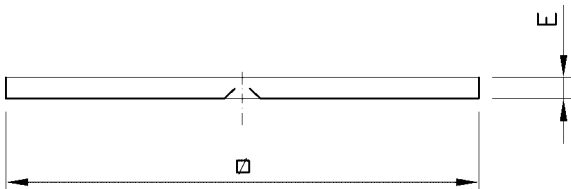

Panel for modular ceiling. DF-RQ			
Basic size	Minimum standardized panel		
	Dimensions	Panel code	E
28	494 x 494	50	6
36	594 x 594	60	10
40	670 x 670	67	10
48	795 x 795	80	10

**Square panels for plaster false ceiling, installation type: DF-RQ-E. Dimensions and coding.**

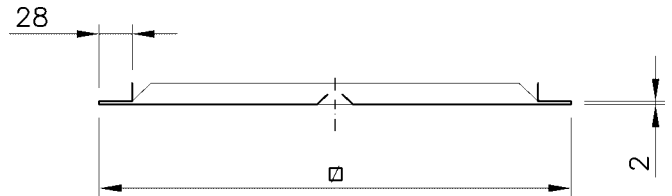

Panel for plaster ceiling: DF-RQ-E		
Basic size	Minimum standardized panel	
	Dimensions	Panel code
28	520 x 520	52
36	620 x 620	62
40	695 x 695	69
48	820 x 820	82

**Note:** This installation model has no sharp edges..

**Plenum with lateral connection for diffusers integrated in square panels, PQ model.**

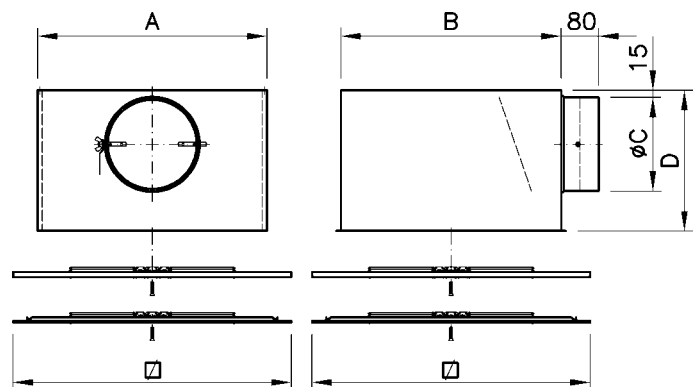

Basic size	A	B	C	D
28	488	470	199	300
36	588	570	249	350
40	663	645	314*	350
48	788	770	314	410

(\*) In oval model.



## DF-RQ swirl diffusers

### Coding for purchase orders. Example

Coding provides a unique description of the model ordered by the customer.

<b>DF-RQ</b>	Square panel/Modular ceiling
<b>DF-RQ-E</b>	Square panel/Plaster ceiling

Standard panel finish in white (RAL 9010), other finishes available by special order.

<b>28, 36, 40, 48</b>	Basic size / No. of slots
-----------------------	---------------------------

Standard deflectors in black (RAL 9005). White (RAL 9010) finishes available by special order.

<b>50, 60, 67, 80</b>	Panel code <b>DF-RA</b>
<b>52, 62, 69, 82</b>	Panel code <b>DF-RA-E</b>

Check compatibility with the basic sizes.

<b>PQ</b>	Plenum with lateral connection for <b>DF-RQ</b> and <b>DF-RQ-E</b>
<b>PQA</b>	Same as above, internally insulated

Special installations by special order

<b>RE</b>	Manual damper accessible from false ceiling.
<b>RL</b>	Manual damper accessible from room
<b>RM</b>	Damper equipped to allow motorization

Coding example:

**DF-RQ/2860/ PQ/RM**

Description:

Adjustable-blade swirl diffuser, **DF-RQ** model, size 28, in square panel of 594 x 594, with laterally connected plenum and volume control damper to allow motorization. Front panel in white (RAL 9010) with deflectors in black (RAL 9005).

# Selection table

## DF-RQ (air stream between diffusers)

DF-RQ (air stream between diffusers)															
Q		No. of slots	28			36			40			48			
m <sup>3</sup> /h	l/s		1,2	1,8	2,7	1,2	1,8	2,7	1,2	1,8	2,7	1,2	1,8	2,7	
250	69,4	V <sub>z</sub>	H = 2,7	0,12	0,14	0,11									
			H = 3,2	0,07	0,09	0,07									
			H = 3,8	0,05	0,06	0,05									
		ΔP <sub>t</sub> (Pa)	6												
		L <sub>WA</sub>	<15												
400	111,1	V <sub>z</sub>	H = 2,7	0,19	0,23	0,18	0,14	0,17	0,12	0,13	0,15	0,11			
			H = 3,2	0,12	0,15	0,11	0,09	0,11	0,08	0,08	0,09	0,07			
			H = 3,8	0,08	0,10	0,08	0,06	0,07	0,05	0,06	0,06	0,05			
		ΔP <sub>t</sub> (Pa)	17			7			4						
		L <sub>WA</sub>	29			<15			<15						
550	152,8	V <sub>z</sub>	H = 2,7	0,26	0,32	0,25	0,19	0,23	0,17	0,18	0,20	0,15	0,16	0,17	0,13
			H = 3,2	0,16	0,20	0,16	0,12	0,14	0,10	0,11	0,13	0,10	0,10	0,11	0,08
			H = 3,8	0,11	0,14	0,11	0,08	0,10	0,07	0,08	0,09	0,07	0,07	0,07	0,06
		ΔP <sub>t</sub> (Pa)	31			13			7			5			
		L <sub>WA</sub>	38			25			18			<15			
700	194,4	V <sub>z</sub>	H = 2,7	0,33	0,41	0,32	0,24	0,29	0,21	0,23	0,25	0,20	0,21	0,22	0,17
			H = 3,2	0,21	0,26	0,20	0,15	0,18	0,13	0,15	0,16	0,12	0,13	0,14	0,11
			H = 3,8	0,14	0,18	0,14	0,11	0,13	0,09	0,10	0,11	0,09	0,09	0,09	0,07
		ΔP <sub>t</sub> (Pa)	51			20			11			8			
		L <sub>WA</sub>	46			32			25			20			
850	236,1	V <sub>z</sub>	H = 2,7	0,30	0,35	0,26	0,28	0,31	0,24	0,25	0,26	0,21			
			H = 3,2	0,19	0,22	0,16	0,18	0,19	0,15	0,16	0,16	0,13			
			H = 3,8	0,13	0,15	0,11	0,12	0,13	0,10	0,11	0,11	0,09			
		ΔP <sub>t</sub> (Pa)	30			16			12						
		L <sub>WA</sub>	38			31			26						
1000	277,8	V <sub>z</sub>	H = 2,7	0,35	0,41	0,30	0,33	0,36	0,28	0,30	0,31	0,25			
			H = 3,2	0,22	0,26	0,19	0,21	0,23	0,18	0,19	0,19	0,15			
			H = 3,8	0,15	0,18	0,13	0,14	0,16	0,12	0,13	0,13	0,11			
		ΔP <sub>t</sub> (Pa)	41			23			17						
		L <sub>WA</sub>	43			36			31						
1200	333,3	V <sub>z</sub>	H = 2,7	0,42	0,49	0,36	0,40	0,43	0,34	0,35	0,37	0,30			
			H = 3,2	0,26	0,31	0,23	0,25	0,27	0,21	0,22	0,23	0,19			
			H = 3,8	0,18	0,21	0,16	0,17	0,19	0,15	0,15	0,16	0,13			
		ΔP <sub>t</sub> (Pa)	60			33			25						
		L <sub>WA</sub>	49			42			37						
1500	416,7	V <sub>z</sub>	H = 2,7	0,49	0,54	0,42	0,44	0,46	0,37						
			H = 3,2	0,31	0,34	0,27	0,28	0,29	0,23						
			H = 3,8	0,22	0,24	0,18	0,19	0,20	0,16						
		ΔP <sub>t</sub> (Pa)	51			39									
		L <sub>WA</sub>	49			44									
1800	500,0	V <sub>z</sub>	H = 2,7								0,53	0,55	0,45		
			H = 3,2								0,33	0,34	0,28		
			H = 3,8								0,23	0,24	0,19		
		ΔP <sub>t</sub> (Pa)								56					
		L <sub>WA</sub>								50					

Example: DF-RQ 3660 diffuser (36 slots)

Initial data

Q = 850 m<sup>3</sup>/h

B = 1,8 m.

H = 3,2 m.

Results

L<sub>WA</sub> = 38 dB(A)

V<sub>z</sub> = 0,22 m/s

ΔPt = 30 Pa

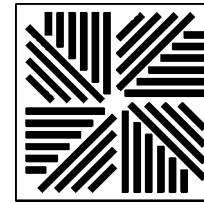

**DF-RQ 3660**  
36 slots

Symbols:

V<sub>z</sub> = Velocity in occupied area, in m/s

B = Distance between diffuser axes, in m

Q = Air flow

ΔPt = Total pressure drop, in Pa

H = Room height, in m

LWA = Sound power, in dB(A)

# Selection table

## DF-RQ (air stream toward the wall)

DF-RQ (air stream toward the wall)																		
Q		No. of slots			28			36			40			48				
m <sup>3</sup> /h	l/s	X			0,6	1,5	2,1	0,6	1,5	2,1	0,6	1,5	2,1	0,6	1,5	2,1		
250	69,4	V <sub>z</sub>	H = 2,7	0,22	0,13	0,11												
			H = 3,2	0,16	0,11	0,09												
			H = 3,8	0,12	0,09	0,08												
		ΔP <sub>t</sub>			6													
		L <sub>WA</sub>			<15													
400	111,1	V <sub>z</sub>	H = 2,7	0,35	0,22	0,17	0,24	0,15	0,12	0,23	0,14	0,11						
			H = 3,2	0,26	0,18	0,15	0,18	0,12	0,10	0,17	0,12	0,10						
			H = 3,8	0,20	0,15	0,13	0,14	0,10	0,09	0,13	0,10	0,08						
		ΔP <sub>t</sub>			17			7			4							
		L <sub>WA</sub>			29			<15			<15							
550	152,8	V <sub>z</sub>	H = 2,7	0,47	0,30	0,24	0,33	0,21	0,17	0,31	0,19	0,16	0,28	0,17	0,14			
			H = 3,2	0,36	0,25	0,20	0,25	0,17	0,14	0,23	0,16	0,13	0,21	0,14	0,12			
			H = 3,8	0,27	0,20	0,17	0,19	0,14	0,12	0,18	0,13	0,11	0,16	0,12	0,10			
		ΔP <sub>t</sub>			31			13			7			5				
		L <sub>WA</sub>			38			25			18			<15				
700	194,4	V <sub>z</sub>	H = 2,7	0,60	0,38	0,30	0,42	0,26	0,21	0,40	0,25	0,20	0,35	0,22	0,18			
			H = 3,2	0,45	0,31	0,26	0,32	0,22	0,18	0,30	0,20	0,17	0,26	0,18	0,15			
			H = 3,8	0,35	0,26	0,22	0,24	0,18	0,15	0,23	0,17	0,14	0,20	0,15	0,13			
		ΔP <sub>t</sub>			51			20			11			8				
		L <sub>WA</sub>			46			32			25			20				
850	236,1	V <sub>z</sub>	H = 2,7	0,51	0,32	0,26	0,48	0,30	0,24	0,43	0,27	0,21						
			H = 3,2	0,38	0,27	0,22	0,36	0,25	0,21	0,32	0,22	0,18						
			H = 3,8	0,30	0,22	0,19	0,28	0,21	0,18	0,25	0,18	0,16						
		ΔP <sub>t</sub>			30			16			12							
		L <sub>WA</sub>			38			31			26							
1000	277,8	V <sub>z</sub>	H = 2,7	0,60	0,38	0,30	0,57	0,35	0,28	0,50	0,32	0,25						
			H = 3,2	0,45	0,31	0,26	0,42	0,29	0,24	0,38	0,26	0,22						
			H = 3,8	0,35	0,26	0,22	0,33	0,24	0,21	0,29	0,22	0,18						
		ΔP <sub>t</sub>			41			23			17							
		L <sub>WA</sub>			43			36			31							
1200	333,3	V <sub>z</sub>	H = 2,7	0,72	0,45	0,36	0,68	0,42	0,34	0,61	0,38	0,30						
			H = 3,2	0,54	0,37	0,31	0,51	0,35	0,29	0,45	0,31	0,26						
			H = 3,8	0,42	0,31	0,26	0,39	0,29	0,25	0,35	0,26	0,22						
		ΔP <sub>t</sub>			60			33			25							
		L <sub>WA</sub>			49			42			37							
1500	416,7	V <sub>z</sub>	H = 2,7	0,85	0,53	0,42	0,76	0,47	0,38									
			H = 3,2	0,64	0,44	0,36	0,57	0,39	0,32									
			H = 3,8	0,49	0,36	0,31	0,44	0,32	0,28									
		ΔP <sub>t</sub>			51			39										
		L <sub>WA</sub>			49			44										
1800	500,0	V <sub>z</sub>	H = 2,7												0,91	0,57	0,45	
			H = 3,2												0,68	0,47	0,39	
			H = 3,8												0,52	0,39	0,33	
		ΔP <sub>t</sub>														56		
		L <sub>WA</sub>														50		

Example: DF-RQ 3660 diffuser (36 slots).

Initial data  
 Q = 700 m<sup>3</sup>/h  
 B = 1,5 m.  
 H = 3,2 m.

Results  
 L<sub>WA</sub> = 32 dB(A)  
 V<sub>z</sub> = 0,22 m/s  
 ΔPt = 20 Pa

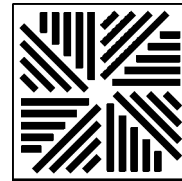

DF-RQ 3660  
36 Slots

Symbols:  
 V<sub>z</sub> = Velocity in occupied area, in m/s  
 X = Distance between diffuser axis and wall, in m  
 Q = Air flow                      ΔP<sub>t</sub> = Total pressure drop, in Pa  
 H = Room height, in m              L<sub>WA</sub> = Sound power, in dB(A)

# Selection graphs for DF-RQ 28 and 36 slots

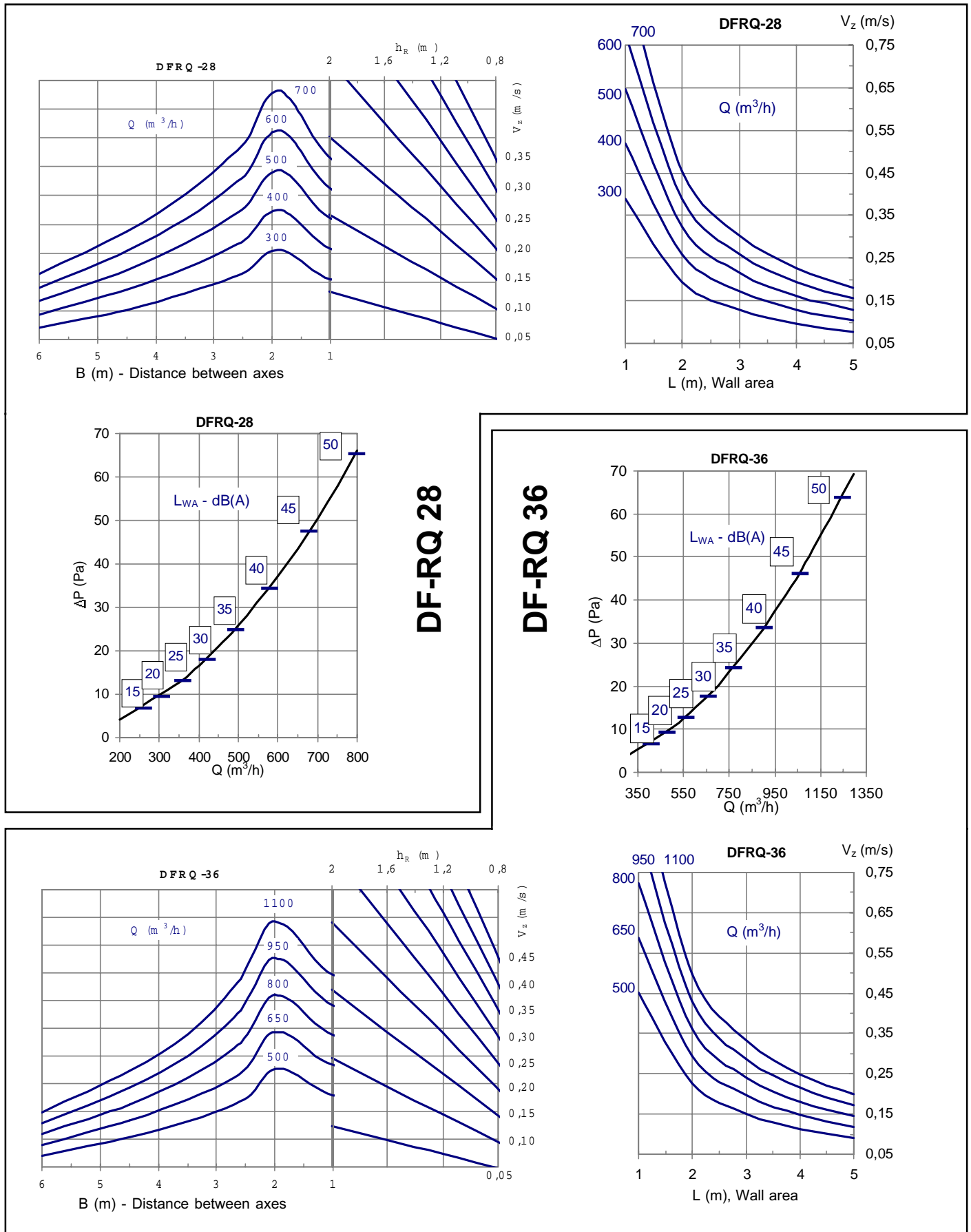

## Selection graphs for DF-RQ 40 and 48 slots

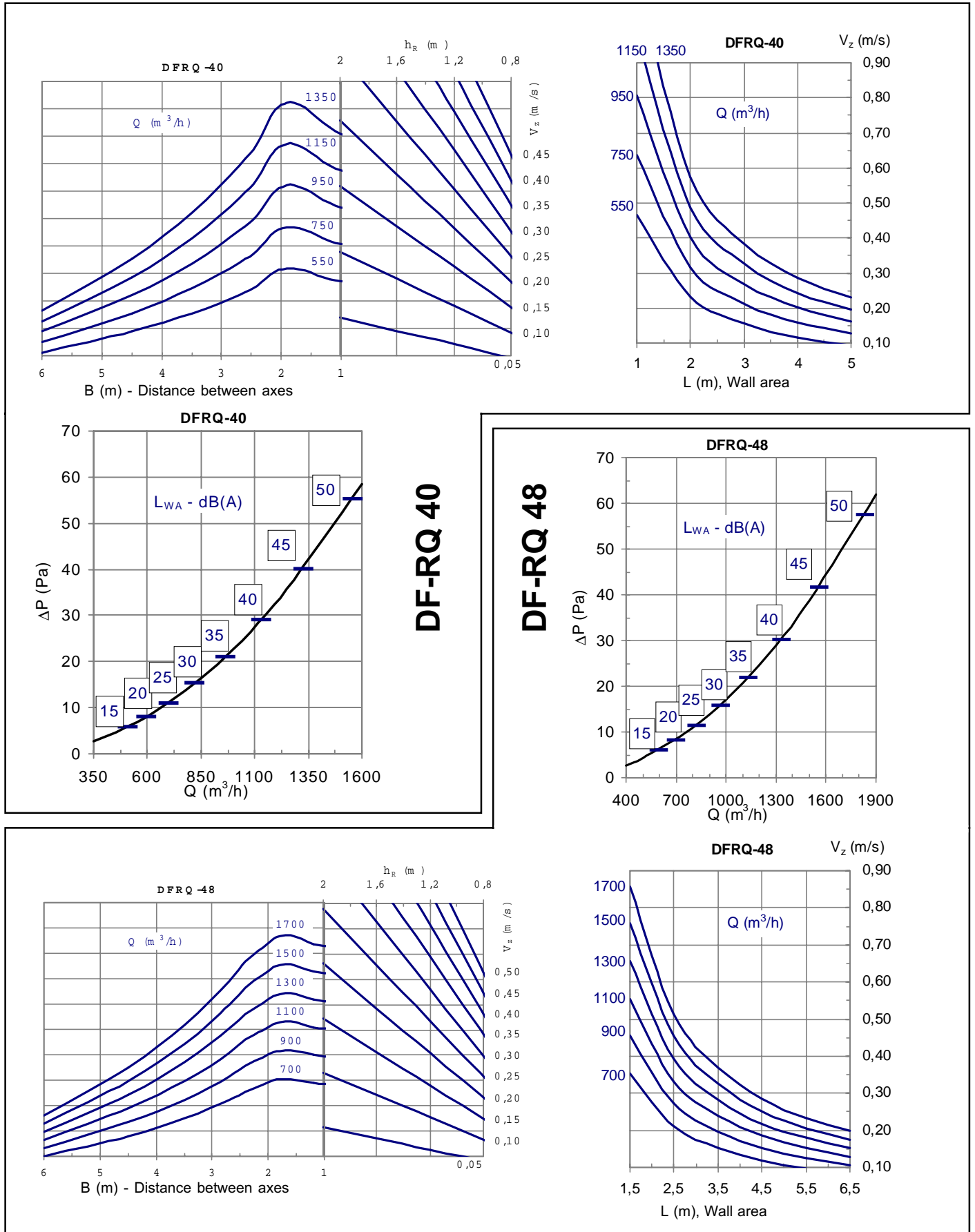

## Adjustable-blade swirl diffusers

### Research, design and innovation

For facility-related reasons, it is often necessary to adapt to different kinds of modular false ceilings.

The R&D Department has designed an extensive variety of swirl diffusers adapted to widely different geometries and different features than those usually offered: diffusers integrated into rectangular panels (1200x300) inserting the diffuser inside an ellipse, as shown in the photo below; variable geometry swirl diffusers with no need for outside power, such as the

diffuser in the side photo, with horizontal or rotational air supply in the case of cold air and vertical air supply in the case of hot air, etc.

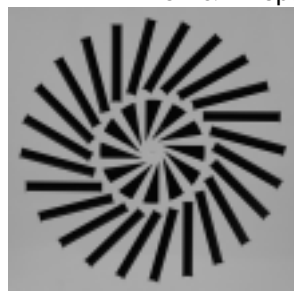

The air diffusion test room (dimensions 9 m x 5.6 m; adjustable height from 2.0 to 4.0 m) allows on-site verification of the suitability of the product developed by our R&D Department or by any of the parties involved in the installations (architects, engineers, installers, etc.) with whom we work regularly on the development of new products.



The temperature, residual velocity, etc. are measured during the testing process, and air supply tests are done with smoke for clear visualization of air distribution in the room.

Our facilities are also equipped with a reverberation room, constructed to ISO standards, where the sound pressure levels generated by the different units can be determined with a high degree of precision.



A complete set of equipment is also available for on-site testing: calibration balometer, portable sound level meter, propeller and hot-wire air flow meters, pressure gauges, etc.



## Adjustable-blade swirl diffusers

Research, design and innovation

